

# Smart Generation

POWERING ONTARIO WITH RENEWABLE ENERGY



David  
Suzuki  
Foundation

# Smart Generation

POWERING ONTARIO WITH RENEWABLE ENERGY



David  
Suzuki  
Foundation

SOLUTIONS ARE IN OUR NATURE

A summary of this report is available at [www.davidsuzuki.org](http://www.davidsuzuki.org)

**Smart Generation:  
Powering Ontario With Renewable Energy**

© 2004 the David Suzuki Foundation

ISBN 0-9689731-8-3

Canadian Cataloguing in Publication Data for this book  
is available through the National Library of Canada

**Authors**

Jose Etcheverry  
Paul Gipe  
William Kemp  
Roger Samson  
Martijn Vis  
Bill Eggertson  
Rob McMonagle  
Sarah Marchildon  
Dale Marshall

**Reviewers**

We would like to thank the following reviewers for their valuable feedback and suggestions: Greg Allen; Alex Boston; Morag Carter; Phil Jessup; Joyce Maclean; Elliot Mainzer; Roger Peters; Keith Stewart; and Martin Tampier.

**Acknowledgements**

Special thanks to Dominic Ali, Marvin Breyfogle, Jenny Brown, Lyn Brown, Martin Cloutier, Dave Colquhoun, Mark Drisdelle, Shannon Elliot, Serena Etcheverry, John Finch, Lauri Gregg, Claudia Ho Lem, Matt Horne, Robert Hornung, Mike Johnson, Christian Kjaer, Byron Leclair, Paul Lingl, Tamara Nowakowsky, John Owen, Gerald Richardson, Janet Sawin, Sari Sikstrom, Paul Skelhorne, Ana Simeon, Dave Taylor, Claire Viviere, John Wellner, and Duncan Wilcock for their valuable collaboration.

This project was made possible through generous financial contributions from numerous individuals and:



David Suzuki Foundation  
2211 West 4th Ave., Suite 219  
Vancouver, BC  
Canada V6K 4S2  
Email: [coast@davidsuzuki.org](mailto:coast@davidsuzuki.org)  
Website: [www.davidsuzuki.org](http://www.davidsuzuki.org)  
Tel (604) 732-4228  
Fax (604) 732-0752

Photographs on page 11 by Lauri Gregg; pages 23, 25 by Paul Gipe; page 29 by Dave Colquhoun; pages 37, 39, 42 by William Kemp; page 43 by Byron Leclair; page 62 by Mark Drisdelle; page 77 by Martin Cloutier; page 78 by Enwave; page 79 by Marvin Breyfogle and Gerald Richardson; and page 104 by Automation Tooling Systems; page 110 by U.S. National Renewable Energy Laboratory.

Design and production by Alaris Design

Printed in Canada by Western Printers and Lithographers

Cover printed on Save-A-Tree® Gloss Cover; inside pages printed on Envirographic 100®; both papers are 100% recycled, post-consumer waste; process chlorine-free. All inks vegetable-based.

# Table of Contents

<b>I INTRODUCTION AND SUMMARY</b> .....	1
<b>1. Introduction</b> .....	1
<b>2. Ontario’s current electricity situation</b> .....	2
<b>3. Current electricity path threatens Ontario</b> .....	3
<b>4. Clean alternatives for meeting Ontario’s power needs</b> .....	4
<b>5. The pitfalls of natural gas</b> .....	5
<b>6. Benefits of renewable energy in Ontario</b> .....	6
<i>Wind</i> .....	6
<i>Hydroelectricity</i> .....	6
<i>Biomass</i> .....	7
<i>Solar</i> .....	7
<i>Geothermal</i> .....	7
<b>7. Renewable energy mechanisms (REM)</b> .....	7
<i>Key Source of REM: Germany’s Renewable Energy Feed-In Law</i> .....	8
<i>Spain’s REM</i> .....	8
<i>Danish REM</i> .....	9
<i>Other Countries with REM</i> .....	9
<b>8. Conclusion and recommendations</b> .....	10
<b>II WIND POWER IN ONTARIO</b> .....	17
<b>Summary</b> .....	17
<b>1. Background on wind energy</b> .....	17
1.1 <i>Worldwide wind development</i> .....	17
1.2 <i>Wind energy is a mature business</i> .....	18
1.3 <i>Technical considerations</i> .....	18
1.4 <i>Benefits of Wind Energy</i> .....	20
<b>2. Ontario’s wind resource: waiting to be discovered</b> .....	22
2.1 <i>Estimating Ontario’s wind resources</i> .....	23
2.2 <i>Technical resources</i> .....	23
2.3 <i>Practical resource</i> .....	23
2.4 <i>Accessible resource</i> .....	23
2.5 <i>Acceptable resource</i> .....	24

2.6 Ontario's achievable wind contribution .....	24
2.7 Growth quickens in new markets .....	24
<b>3. Policies, mechanisms, and incentives to enhance wind power implementation .....</b>	<b>25</b>
3.1 Public Utility Regulatory Policies Act .....	25
3.2 Standard offer contracts .....	26
3.3 Direct subsidies .....	26
3.4 Indirect subsidies .....	26
3.5 Renewable portfolio standards .....	26
3.6 Tendering or bidding systems .....	27
3.7 Renewable Energy Mechanisms (REM) .....	28
<b>4. Conclusions and further research .....</b>	<b>28</b>
<b>III HYDROELECTRICITY IN ONTARIO .....</b>	<b>33</b>
<b>Summary .....</b>	<b>33</b>
<b>1. Background on hydropower .....</b>	<b>33</b>
1.1 Worldwide hydropower development .....	34
1.2 Hydropower is an established business .....	34
1.3 Technical considerations .....	35
1.4 Integrating existing hydroelectric facilities with new wind plants .....	35
1.5 The effect of intermittent generation .....	36
1.6 Benefits of new hydropower development .....	37
1.7 Employment .....	37
1.8 Local economic development .....	37
<b>2. Ontario's hydroelectric resources: key foundation of provincial power .....</b>	<b>38</b>
2.1 Estimates of Ontario's Total Hydroelectric Resources .....	38
2.2 Technical resources .....	38
2.3 Practical resource .....	39
2.4 Accessible resource .....	39
2.5 Acceptable resource .....	39
2.6 Ontario's achievable potential .....	39
2.7 Economies of scale for hydropower .....	40
<b>3. Policies, mechanisms, and incentives to enhance the viability of Ontario's hydroelectric power .....</b>	<b>40</b>
<b>4. Conclusions and further research .....</b>	<b>41</b>
<b>IV BIOMASS IN ONTARIO .....</b>	<b>45</b>
<b>Summary .....</b>	<b>45</b>
<b>1 Background on biomass .....</b>	<b>45</b>
1.1 Worldwide biomass development .....	47

<b>2. Biomass is growing as a competitive energy source in Ontario</b> .....	48
2.1 <i>Technology considerations</i> .....	48
2.2 <i>Combustion applications for heat</i> .....	48
2.3 <i>Electricity from biomass</i> .....	49
2.4 <i>Anaerobic digestion</i> .....	50
2.5 <i>Economics of power generation from biomass</i> .....	50
2.6 <i>Benefits of biomass</i> .....	50
2.7 <i>Employment</i> .....	50
2.8 <i>Rural development</i> .....	51
<b>3. Ontario's biomass resource: A growing diversity of supply</b> .....	51
3.1 <i>Forest sector biomass</i> .....	51
3.2 <i>Technical resource estimation</i> .....	51
3.3 <i>Practical resource estimation</i> .....	52
3.4 <i>Agriculture</i> .....	53
3.5 <i>Waste biomass resources from urban areas</i> .....	56
<b>4. Overview: the total, technical, and practical resources available</b> .....	58
<b>5. Ontario's achievable biomass contribution</b> .....	58
5.1 <i>Achievable contribution (2010–2020)</i> .....	58
5.2 <i>Estimated contribution (2007)</i> .....	59
5.3 <i>Growth quickens in new markets</i> .....	60
<b>6. Policies, mechanisms, and incentives to enhance biomass implementation</b> .....	61
<b>7. Conclusions, recommendations and further research</b> .....	61
<b>Biomass Appendix</b> .....	63
<b>V GEOTHERMAL HEAT PUMPS</b> .....	67
<b>Summary</b> .....	67
<b>1. Background</b> .....	67
1.1 <i>Costs</i> .....	68
1.2 <i>GHP development</i> .....	69
1.3 <i>Technical considerations</i> .....	70
1.4 <i>Benefits of GHP</i> .....	71
1.5 <i>Employment</i> .....	71
1.6 <i>Economic development</i> .....	72
<b>2. Ontario's GHP resource</b> .....	72
2.1 <i>Growth quickens in new markets</i> .....	73
<b>3. Mechanisms to encourage GHP</b> .....	73
<b>4. Recommendations</b> .....	75
<b>5. Conclusions</b> .....	75
<b>GHP Appendix</b> .....	76

<b>VI SOLAR ENERGY</b> .....	81
<b>Summary</b> .....	81
<b>1. Background on solar energy</b> .....	82
1.1 <i>Worldwide solar development</i> .....	83
1.2 <i>Solar energy is a rapidly growing business</i> .....	84
1.3 <i>Technical considerations</i> .....	84
1.4 <i>Benefits of solar energy</i> .....	86
1.5 <i>Employment</i> .....	86
1.6 <i>Economic development</i> .....	88
<b>2. Ontario's solar resource: waiting to be tapped</b> .....	88
2.1 <i>Estimating Ontario's solar resources</i> .....	88
2.2 <i>Technical resources</i> .....	88
2.3 <i>Practical resource</i> .....	93
2.4 <i>Acceptable resource</i> .....	94
2.5 <i>Ontario's achievable solar contribution</i> .....	97
2.6 <i>Growth quickens in new markets</i> .....	98
<b>3. Policies, mechanisms, and incentives to enhance solar power implementation</b> .....	98
3.1 <i>Solar electricity (PV)</i> .....	98
3.2 <i>Solar thermal</i> .....	99
<b>4. Conclusions and further research</b> .....	103
<b>VII CONCLUSION</b> .....	109
<b>Summary</b> .....	109
<b>APPENDIX: ONTARIO ENERGY PROFILE</b> .....	111
<b>Summary</b> .....	111
<b>1. Present structure of Ontario's electricity sector</b> .....	111
<i>Expected Electricity Price</i> .....	111
<b>2. Heat demand</b> .....	112
<i>Residential sector</i> .....	112
<i>Commercial and institutional sector</i> .....	112
<b>3. Price of heat</b> .....	113
<b>GLOSSARY OF KEY TERMS</b> .....	115

# 1

## Introduction and Summary

### 1. Introduction

ONTARIO IS AT AN energy crossroads: the province can either continue to rely on polluting sources to generate electricity and meet the province's demands for heating and cooling, or it can invest in the development of a reliable and sustainable system based on renewable energy and efficiency.

The province's electricity system was originally built on a renewable foundation: hydropower. However, the system is currently dominated by large outdated facilities that burn coal—the most polluting fossil fuel—and by aging nuclear plants, which are characterized by unresolved safety issues (e.g. safe disposal of radioactive waste), chronic underperformance, and massive cost overruns. In addition, the 2003 blackout illustrated the vulnerability of the current electricity system, which depends heavily on large centralized plants overwhelming a fragile electric grid.

Recently, Ontario's Minister of Energy estimated that fixing the province's electricity system will require between \$25 to \$40 billion dollars.<sup>1</sup>

Crucial decisions related to this investment will be made in the coming months and could perpetuate the problems of the current system or can instead result in positive changes that will permanently improve the reliability and sustainability of the province's electricity system.

This vast investment presents a unique opportunity to decrease electricity demand through efficiency measures, and shift to renewable energy options, substantially improving the electricity system, increasing energy security, and benefiting the environment and the economy. Developing a diversity of local renewable energy sources throughout the province could help

reduce power losses and increase the reliability and flexibility of Ontario's electricity system.

Ontario's heating needs are now almost all met with natural gas, and natural gas has been widely promoted as a potential alternative to coal generation.

Although natural gas may be a cleaner fuel than coal, its use still impacts air quality and human health, and its production has significant environmental consequences in the form of wilderness and habitat destruction.<sup>2</sup>

Furthermore, the contribution of natural gas generation to climate change is only slightly less than coal (on an energy basis).

Finally, a decrease in natural gas reserves has meant a doubling of its price—with wild price fluctuations—both of which make it a less attractive and more volatile alternative for electricity generation than efficiency strategies and renewable energy.

There is also an opportunity to meet power generation and heating needs using efficiency measures and renewable energy sources instead of natural gas.

To help inform the ongoing decision-making process, this report summarizes the potential of the most salient renewable options available in Ontario: wind, hydropower, biomass, solar, and ground heat.

The report illustrates how the abundant renewable resources of wind and hydropower can be effectively integrated in Ontario to provide a cost-effective, reliable, and clean alternative to conventional generation.

In addition, the report highlights how myriad renewable energy technologies can be used in rural and urban communities throughout the province to achieve a more diverse and reliable electricity system, and also to light, heat, and cool all types of buildings.



The report also identifies key policy mechanisms that can help Ontario become a North American leader in renewable energy and thereby achieve a more stable and reliable electricity system, a cleaner environment, and the development of a new and vibrant economic engine.

## 2. Ontario's current electricity situation

Large and aging coal and nuclear power plants currently dominate Ontario's electricity system.<sup>3</sup>

**TABLE 1**

Ontario's Electricity Mix<sup>4</sup>

Source	GWh	%	Peak (MW)	%	Capacity (MW)
Coal	35,098	23	5,865	23	7,285
Nuclear	61,040	40	7,140	28	10,720
Hydro	33,572	22	6,375	25	7,665
Peaking Gas and Oil	12,208	8	3,060	12	4,645
Imports	10,682	7	3,060	12	
<b>Total Demand</b>	<b>152,600</b>		<b>25,500</b>		<b>30,315</b>

Ontario's generation plants are interconnected to electricity users by a provincially-owned grid that serves an area of 640,000 km<sup>2</sup>. In most locations, generation plants and electricity users are currently located far away from each other, which leads to a continuous average power loss of eight percent as electricity is delivered (totaling a loss close to 2000 megawatts of peak power).<sup>5</sup>

In addition to transmission losses, energy is routinely wasted during electricity generation as both coal and nuclear plants are inefficient at generating electricity.<sup>6</sup>

Decades of relying on supply by a narrow and limited number of large generators, instead of efficiency strategies and a diverse generation portfolio, has characterized Ontario's electricity system. Furthermore, the poor performance and lackluster safety record of Ontario's nuclear facilities has resulted in the current detrimental dependency on provincial coal generators, and has created the most costly ongoing financial liability in Canada's electricity sector.<sup>7</sup>

This financial liability has three main components: accumulated debt accrued until the dissolution of Ontario Hydro in 1999, additional liabilities accumulated by Ontario Power Generation from 1999–2003, and expected and estimated liabilities related to nuclear plant refurbishments.

The accumulated debt from Ontario Hydro totals approximately \$38.1 billion transferred by the provincial government to the Ontario Electricity Financial Corporation upon the restructuring of Ontario's electricity sector on April 1, 1999.<sup>8</sup>

The additional liabilities represent approximately \$1 billion (from the return of Pickering A Unit 4 to service and other nuclear operations) accumulated by Ontario Hydro's successor, Ontario Power Generation, between 1999–2003.<sup>9</sup>

The cost of rebuilding Pickering A, Unit 1 to service is currently estimated by the government to total approximately \$900 million.<sup>10</sup> It is important to note that when the OPG Review Committee recommended the Unit 1 re-start in March 2004, the estimate quoted to complete the project was \$500 million.<sup>11</sup>

Growing concerns about nuclear safety led to a plan to conduct repairs in Ontario's nuclear facilities in 1997.<sup>12</sup> The total refurbishment costs for Ontario nuclear generating facilities have recently been estimated to range between \$14.2 to \$19.2 billion dollars.<sup>13</sup> These significant costs severely compromise the financial health of Ontario's electricity system and should call into question the viability of any further nuclear power development.

In addition to exacerbating Ontario's debt, the required repairs of nuclear facilities increased provincial dependency on coal plants. As coal burning for electricity generation grew, air pollution levels consistently worsened in Ontario. This ongoing problem has become especially severe in southern Ontario during hot summer days that favour smog creation.

Growing health concerns about air pollution resulted in a promise during the 2003 provincial election by the Ontario Liberal government to phase out coal by 2007. This election promise was followed in 2004 by provincial targets to decrease electricity use by 5 percent through efficiency and conservation by 2007, and by goals to increase the use of renewable energy to 5 percent of total energy capacity by 2007 and 10 percent by 2010.

As this report illustrates, these goals represent modest targets that can be surpassed if clear policies are implemented to diversify, encourage, and support the adoption of renewable energy sources throughout the province.

Further evidence for implementing renewable energy sources in Ontario was provided in June 2004 by the more than 4,400 megawatts (MW) of renewable energy bids

submitted as part of the government's request for proposals to develop 300 MW of renewable energy.<sup>14</sup>

Currently hydroelectric facilities represent the main use of renewable energy in Ontario. However, most of these hydroelectric plants are not representative of the low-impact renewable technologies available today (e.g. wind turbines, small hydro facilities, landfill gas, solar photovoltaic).

Presently new renewable technologies are almost absent in Ontario's electricity generation mix. As an example consider wind turbines, which currently represent about 15 MW of installed capacity in Ontario. In stark contrast Germany, with a surface area about one-third the size of Ontario, had by the end of 2003 14,609 MW of installed wind capacity (and in 2003 alone installed 2645 MW of wind capacity).<sup>15</sup>

Although low-impact renewable energy currently represents only two percent of the global share of energy use, renewable sources such as wind power and solar photovoltaic are growing at impressive exponential rates and faster than any other energy sources in the world.

A further indication of the growing importance of the renewable energy sector is the fact that in 2003 about \$26.9 billion – the equivalent of one-sixth of all the global investment in power generation equipment – was spent on renewable energy development.<sup>16</sup>

### 3. Current electricity path threatens Ontario

Ontario's current dependency on coal for electricity generation regularly compromises public health and environmental quality in Ontario.

Severe smog alerts have come to characterize Ontario's summer season, and the burning of coal for electricity generation represents a primary source of local air pollution.<sup>17</sup>

Furthermore, a report released in 2004 by the North American Commission for Environmental Cooperation shows that the province's largest coal plant, Nanticoke, is responsible for eight percent of all of Canada's reported toxic air emissions.<sup>18</sup>

Several recent studies have linked air pollution exposure with negative health consequences, including cardiovascular, respiratory, developmental impairments and lung cancer.<sup>19</sup> For several years the Ontario Medical Association (OMA) has highlighted the acute health

effects associated with fine particulate matter and ground-level ozone in Ontario, which cost over \$1 billion per year in direct costs for hospital admissions, emergency room visits and absenteeism.<sup>20</sup>

The OMA has noted that these estimates do not reflect the costs associated with medication or visits to doctors' offices. Quantification of these costs entails significant ethical dilemmas; nevertheless, data published by the OMA indicates that the pain, suffering, and loss of life associated with air pollution costs Ontario citizens another \$9 billion per year.<sup>21</sup>

In addition to their direct contribution to air pollution, the latest government figures indicate that coal plants also produce about 17 percent of all the greenhouse gas (GHG) emissions of Ontario – an amount comparable to the GHG emissions of all of Ontario's automobiles and light-duty trucks combined.<sup>22</sup>

Scientists worldwide agree that GHG emissions from the burning of fossil fuels, such as coal, oil, and natural gas are the key contributors to climate change.<sup>23</sup>

In recognition of the severity of the challenges posed by climate change, the federal government ratified the Kyoto Protocol in 2002, which commits Canada to reduce its GHG emissions by 6 percent per year (from 1990 levels) by 2012. This commitment entails reducing annual greenhouse gas (GHG) emissions by 240 megatonnes (MT).<sup>24</sup>

Replacing coal generation with a combination of renewable energy and efficiency measures would enable Ontario to reduce air pollution and significantly reduce its share of GHG emissions, and thereby help Canada fulfill its international obligations.<sup>25</sup> Efforts to implement such strategies should be explicitly supported at the national level as part of Canada's Kyoto implementation plan.

Furthermore, the synergistic benefits of such federal and provincial collaboration are highlighted by evidence from European jurisdictions, which suggests that a proportion of the implementation costs of Kyoto policies can be recuperated by reduced costs of air pollution.<sup>26</sup>

A recently signed memorandum of understanding between Ontario and the federal government constitutes a first step towards developing and implementing a new set of collaborative policy measures to ensure that renewable energy sources and efficiency strategies are developed to their fullest potential.

The public health and environmental costs of burning coal (e.g. air pollution, emission of GHGs), and of relying on nuclear power are significant (e.g. safely disposing of

radioactive waste), but are not yet accounted in any way in the pricing of electricity.

In addition, the price of electricity generated from burning coal is also artificially lowered through the favourable federal income tax treatment of coal mining.<sup>27</sup>

In the case of nuclear power, a viable solution for nuclear waste disposal still remains as an unanswered and costly question. Consider that the Auditor General of Canada noted almost ten years ago that a long-term solution for high-level radioactive waste was estimated by Atomic Energy of Canada Limited to cost \$9 billion (in 1991 dollars).<sup>28</sup>

Additionally, instead of reflecting its environmental and social costs, the price of nuclear energy has been artificially lowered for decades through at least \$6 billion of direct federal government subsidies that have existed since 1946 (in the 1987–1999 period, federal spending on nuclear technology totaled about \$2 billion).<sup>29</sup>

The fact that significant costs are largely ignored but are still paid through public funds (e.g. provincial health care budgets) greatly distorts the real price of coal and nuclear electricity.

If all the environmental and social costs and existing government subsidies for coal and nuclear power were taken into account, renewable energy sources would not require any special support to compete.<sup>30</sup>

However, since efforts to reflect these costs and subsidies in electricity prices have not been conducted and are not yet planned, policy measures are required to level the playing field.

#### 4. Clean alternatives for meeting Ontario's power needs

Several recent studies have analyzed the huge potential for reducing electricity use in Ontario through efficiency and conservation.<sup>31</sup>

These studies highlight two important facts for policy-makers: the bulk of all investments in energy efficiency can be paid through the expected energy savings; and just as with renewable energy development, energy efficiency investments can result in important local economic benefits (such as employment creation).<sup>32</sup>

It must be recognized that only a few measures, such as peak reductions achieved through demand response measures by large electricity users, can be implemented as single concerted efforts.<sup>33</sup> Almost all the other strategies to achieve the efficiency gains summarized in Table 2 will require an integrated set of policies and initiatives covering a broad spectrum of activities and products.

Clear evidence already exists in North America showing what can be accomplished in Ontario through

**TABLE 2**  
Energy Efficiency Potential in Ontario<sup>34</sup>

	2010			2015			2020		
	GWh	Peak (MW)	Capacity (MW)	GWh	Peak (MW)	Capacity (MW)	GWh	Peak (MW)	Capacity (MW)
IMO Forecast	164,000	27,800		172,000	28,742		180,000	30,079	
Demand Reductions-Efficiency/ Cogeneration	(26,867)	(4,510)		(53,002)	(8,898)		(73,499)	(12,339)	
Additional Load Shifting		(2,329)			(1,984)			(1,774)	
On-Site Solar Roofs Program	(876)	(250)	330	(1752)	(500)	670	(2,628)	(750)	1,000
Grid Demand	136,257	20,711		117,246	17,360		103,873	15,216	
Existing Nuclear	51,246	5,994	9,000	22,776	2,664	4,000			
Existing Hydro	33,572	6,375	7,665	33,572	6,375	7,665	33,572	6,375	7,665
Existing Peaking Gas and Replaced Oil	12,208	3,060	4,645	12,208	3,060	4,645	12,208	3,060	4,645
Wind	7,884	1,317	3,000	13,140	2,196	5,000	18,396	3,074	7,000
New Hydro	4,380	600	1,000	6,570	900	1,500	8,760	1,200	2,000
Biomass	3,504	234	500	4,205	281	600	5,606	375	800
New CCNG Base Load	23,915	3,570	4,200	25,054	3,740	4,400	25,623	3,825	4,500
Total Supply	136,709	21,150	30,010	117,525	19,216	27,810	104,165	17,909	26,610
<b>Contingency</b>	<b>452</b>	<b>440</b>		<b>278</b>	<b>1,856</b>		<b>292</b>	<b>2,693</b>	

efficiency strategies. A noteworthy example is the state of California, which has already reduced peak power demand by 20% or 10,000 MW over the past 20 years by relying on efficiency standards (for buildings and appliances) and utility demand side management programs.<sup>35</sup>

In early 2004, the Pembina Institute released a study that showed that electricity consumption and peak demand could be reduced to 30% below 2004 levels by 2020 through a series of energy efficiency and demand reduction policies. These policies would include equipment efficiency standards and codes, demand-side management incentives to utilities, a small public benefits charge to finance energy efficiency, and efforts to fast track efficiency improvements. The study also showed that the cost to Ontario consumers to achieve these goals would be less than adding new supply facilities, and that no new technologies would be required – just the most efficient that are commercially available today.

The Pembina study also looked at how the remaining demand for electricity might be met through a combination of renewable energy and natural gas – eliminating both coal and nuclear energy sources by 2020. This work confirmed similar research carried out by Torrie Smith in 2003.<sup>36</sup>

Both the Pembina Institute and Torrie Smith studies used available data on renewable resource potential.

This report was commissioned to obtain a better assessment of Ontario's renewable electricity potential and also estimate the thermal contribution that these resources could provide.

## 5. The pitfalls of natural gas

Natural gas has been widely promoted as a potential alternative to coal generation, and as the primary source of heat for buildings and industrial processes.

Although natural gas may be a cleaner fuel than coal, its use still impacts air quality and human health, and its production has significant environmental consequences in the form of wilderness and habitat destruction.<sup>37</sup>

Furthermore, the contribution of natural gas generation to climate change is only slightly less than coal (on an energy basis).

Finally, a decrease in natural gas reserves has meant a doubling of its price – with wild price fluctuations – both of which make it a less attractive and more volatile alternative for electricity generation than efficiency strategies and renewable energy.

Contrary to its clean image, natural gas contributes to climate change. Although burning natural gas produces fewer greenhouse gas emissions than coal or oil (25–40% lower, per unit of generated electricity), natural gas still creates emissions when it is produced, processed, and transported.<sup>38</sup>

Further, there are two significant unresolved issues related to the economic costs of increasing reliance on electricity generation from natural gas: price increases and price fluctuations.

Many energy experts are predicting that natural gas prices have established a new equilibrium at \$3.50–\$4.00 per thousand cubic feet (Mcf), compared to the \$2/Mcf mark around which North American gas prices fluctuated over most of the 1980s and 1990s.<sup>39</sup> The reason is that continued growth in gas-fired electricity in North America – driven by U.S. demand – is not matched by proven reserves of natural gas.<sup>40</sup>

Canada is the largest source of natural gas for the U.S., but Canada's reserves are dwindling. Based on proven reserves and 2002 production figures, Canada has only nine years of production unless new reserves are discovered.<sup>41</sup> In the long run, increased supply will not be able to match demand. Already, Canada's natural gas production is expected to decline by 3% between 2002 and 2005 because “many of the new fields coming on-stream are small and quickly depleted.”<sup>42</sup> This reality will keep natural gas prices high in North America, and may potentially increase them further.

In the past, Canadian natural gas consumers – including electricity providers – have been economically buffered from U.S. demand as limited pipeline capacity has meant that natural gas consumers north of the border have not had to compete with the massive U.S. appetite for natural gas. However, this buffer is quickly disappearing. The Alliance Pipeline (B.C. to Illinois), the Maritimes & Northeast Pipeline (Nova Scotia to Massachusetts), and others have meant that more of Canada's natural gas production now gets burned in the U.S. than in Canada. Ironically, increased capacity pushes up the price Canadians pay for Canadian natural gas.<sup>43</sup>

The second price concern relates to the fluctuation in natural gas prices. Like all commodities, natural gas undergoes constant changes in its price. This is especially of concern for electricity utilities with significant amounts of gas-fired power.

Natural gas prices and electricity prices influence each other. When natural gas prices go up, the cost and price

of electricity goes up, and vice versa.<sup>44</sup> Gas-fired power generators have options to decrease the risk of gas price volatility, but these instruments come at a premium.<sup>45</sup> In other words, volatility can be contained, but only by pushing up the price of natural gas even further.

Finally, the option of using natural gas as a “transition fuel” also poses risks. That is because the pipelines required to transport natural gas from its source to power plants are expensive. High pipeline costs have to be spread out by building several gas-fired power plants that last a generation or more.<sup>46</sup>

Instead of committing to such problematic transition, Ontario can emulate the development path of world leaders such as Germany, Spain, and Japan and actively develop the best available renewable technologies.

## 6. Benefits of renewable energy in Ontario

Ontario enjoys a unique comparative advantage due to its abundant and diverse renewable energy sources, which can be used to provide a clean and reliable supply of electricity.

In addition to electricity generation, a variety of renewable energy sources are highly viable to provide heating and cooling (space conditioning) for Ontario’s residential, commercial and institutional buildings. Solar, biomass, and geothermal technologies are better alternatives to the massive use of electricity and fossil fuels (e.g. natural gas, oil and propane) currently employed in space conditioning applications.

Renewable technologies represent safe energy choices, which help protect human health and ecosystems, provide economic and energy security, are easy to put in place and create more jobs than fossil-based generation and nuclear plants.

Wind and solar PV facilities can be built in modular steps (e.g. extra turbines can be added or removed to match electricity demand), do not have fuel costs, and can be implemented faster than any other generation option currently available. Wind plants can be built in just one year, which enables developers to respond more accurately to electricity use projections and short-term changes in demand.<sup>47</sup>

Renewable energy technologies can also be installed as smaller power units along the grid and also directly where electricity is used (a concept known as ‘distributed generation’), an approach that allows reducing the capital

costs and losses of transmission and distribution inherent to centrally generated power.<sup>48</sup> These costs combined can total up to half of delivered power costs.<sup>49</sup> Distributed generation leads to a more stable and secure electricity than the current system based on centralized utilities.

Renewable energy sources represent the biggest source of job creation amongst all power generation options as documented by a comprehensive study released in 2004 by researchers from the University of California.<sup>50</sup>

Because of their greater potential for creating employment, renewable energy policies represent a key tool for community economic development. For example, it is estimated that wind energy projects can support rural communities by providing tax revenues and jobs for rural municipalities and new sources of lease income for rural landowners (\$2,500–\$5,000 a year per turbine).<sup>51</sup>

Ontario enjoys the additional benefits of possessing a skilled labour force and an advanced industrial base that, with the right policies, can become a solid foundation to develop the abundant renewable energy resources available throughout the province. This report examines five sources of renewable energy: wind, hydroelectricity, biomass, solar and geothermal.

### WIND

Wind is the fastest growing source of energy in the world, but Ontario is lagging behind. There is great potential for large-scale wind power generation in the province. The technically achievable wind resource in Southern Ontario is 86 terawatts-hour (TWh) annually, or about 58% of current provincial consumption.

Based on European experience, especially that of Germany and Spain, Ontario could install as much as 8,000 MW of wind-generating capacity by 2012. A fleet of wind turbines representing an installed capacity of 8,000 MW could generate 14 TWh annually, or about 10% of current consumption.

Using the same assumptions as a recent economic impact study of Quebec’s 1,000 MW tender for wind-generating capacity, 8,000 MW of wind capacity installed in Ontario could produce nearly \$14 billion in economic activity and 97,000 person-years of employment.<sup>52</sup>

### HYDROELECTRICITY

Although wind power is an intermittent resource, management techniques can be enacted so that during times of low wind availability, Ontario’s proposed 8,000 MW of wind turbines could be backed up by a

portion of the existing provincial hydroelectric facilities that have water reservoir capacity. Coupling wind power with hydroelectricity is a key strategy to ensure the province has a significant and stable source of renewable electricity when needed.

Furthermore, if coordination measures are implemented to ensure that hydroelectric facilities collaborate with wind power producers, renewable energy can then be used effectively to manage electricity peaks. This innovative integration strategy is currently used in the state of Oregon and provides a viable and practical solution to manage the intermittent nature of renewable resources such as wind.<sup>53</sup>

The province also has an additional 1,000 MW available from small, low-impact hydropower development and potential hydroelectric refurbishments, capable of generating about 5.7 TWh per year.

### **BIOMASS**

Ontario can develop 2,450 MW of power generation using a variety of biomass sources, which can generate 14.7 TWh per year, provide a new source of income for the province's forestry and agricultural sectors, and help deal effectively with their residues. In addition to electricity generation, biomass sources can generate 114 petajoules (PJ) of green heat that can be used to displace electricity and fossil fuels currently used for residential and commercial space heating.

### **SOLAR**

Surveys of the world's solar photovoltaic (PV) market consistently show that growth rates of 30% or more have become an established trend. These high growth rates are leading to a general continuing downward trend in grid-connected PV system prices. Markets for solar water and space heating are also increasing at impressive rates of about 26% per year.

If supportive policies for solar energy are implemented in Ontario the province could install 1,263 MW of PV systems; 800,000 solar domestic hot water systems; 120,000 solar pool heaters; solar passive design in 420,000 new homes; 2,000 000 m<sup>2</sup> of commercial and institutional solar hot water systems; and 825,000 m<sup>2</sup> solar air ventilation systems. The combined energy output of these solar systems has the technically feasible potential of supplying by 2025 the equivalent power that coal provided in 1999, or about half the electricity generated by all of Ontario's nuclear power plants.

### **GEOTHERMAL**

Geothermal heat pumps (GHP) are the most cost-effective option to provide space conditioning (heating and cooling) in Ontario. GHP can be widely used to provide heating and cooling for all new residential and commercial buildings in the province. Ontario could install by 2010, 125,000 residential GHP systems that would provide space conditioning needs (heating and cooling) and save the equivalent of 2,148,400 MWh per year (7.7 PJ). By 2020, the province can install 341,000 residential GHP systems that would provide space conditioning and save the equivalent of 5,777,200 MWh a year (20.8 PJ).

A basic premise of this report is that energy efficiency and conservation strategies are the most logical complement to the widespread use of renewable energy sources. Aggressive energy efficiency measures are essential to ensure that Ontario becomes proficient at obtaining more energy services from lower electricity supply.

## **7. Renewable energy mechanisms (REM)**

The current policy initiatives intended to support renewable energy at the provincial and federal level (e.g. provincial renewable portfolio standard and net metering; existing federal incentives such as the wind power producer incentive and the renewable energy deployment initiative) are not adequate to achieve the high rates of adoption of renewable energy that are possible and necessary in Ontario. A detailed analysis regarding the shortcomings of these existing policy mechanisms is provided in subsequent chapters, in relation to each specific renewable energy technology.

Countries such as Germany, Spain, and Japan are leading the world in the adoption of renewable energy and provide clear examples of what can be quickly achieved if the right policy mechanisms are in place.

Their leadership and success is based on a set of common factors: very active political commitment for renewable energy; supportive education initiatives for R&D and public awareness; strong incentive systems to achieve widespread public participation; and implementation of an effective policy path based on the use of renewable energy mechanisms (REMs).

The concept of REMs is simple: they allow the connection of renewables to the grid and they specify the price paid for renewable generation in the form of

fixed-price contracts. Through an inclusive public policy debate, legislative assemblies determine the premium to be paid for every kilowatt-hour generated from different renewable technologies.

As such, these premiums represent informed, politically negotiated decisions as opposed to politically determined quotas that limit the amount of renewables to be implemented.

Germany, without particularly favourable wind or solar resources, has become the world leader in wind installations and is only second to Japan in solar photovoltaic. Germany currently has over 14,600 MW of installed wind capacity, and in 2003 alone installed 2,645 MW of wind turbines (by comparison the U.K., which has one of the best wind regimes around, has only a total of about 649 MW of wind turbines).<sup>54</sup>

#### **KEY SOURCE OF REM: GERMANY'S RENEWABLE ENERGY FEED-IN LAW**

Germany has become a world leader in renewable energy by implementing a sophisticated renewable energy law (referred here as REM) that has eliminated two of the most important obstacles inhibiting renewable energy development: the ability to connect to the grid, and market uncertainty. The law provides firm prices for an extended period of time to warrant the financial risk of investment – and to ensure market adoption of a variety of renewable options.

One of the first forms of REM originated in 1991, when Germany's conservative government introduced a law requiring utilities across the country to pay 90% of their annual average retail rate for purchases from clean energy sources such as wind turbines. The law, encompassing only a few paragraphs, resulted in an explosion of wind-generated electricity and has positioned Germany as a world leader in renewable energy applications.

In July 2004, the German parliament replaced previous versions of its 'feed-in law' with a new Renewables Act. The act is intended to increase the total contribution of renewable energy to Germany's electricity supply, from 5% to at least 12.5% by 2010 and at least 20% by the year 2020. This is equivalent to renewable portfolio standard (RPS) targets of 12.5% and 20%. However, the mechanism designed to reach targets uses a more sophisticated approach than that in the original feed-in law or that of the renewable portfolio standards

(RPS) currently used in Canada and the United States.

Rather than setting the premium as a percentage of retail rates, the specific premium for each technology was chosen after parliamentary debate informed by technical reports from the German Wind Energy Institute and the Institute for Solar Energy Research. As an example of the practical outcomes of this debate, consider that German parliamentarians chose higher premiums for less windy sites to encourage development in low wind areas of central Germany. Their intent was to disperse wind turbines across the landscape, rather than concentrating huge installations only in the windiest locales. This strategy reduces location problems and potential land-use conflicts, and better integrates the turbines into the electricity network.

By carefully targeting the premiums to be paid for wind and other renewables, Germany's REM law aims to diversify the use of a variety of renewable energy technologies, and achieve sustained market transformations.

The renewable premiums are revisited twice a year to monitor how the program is meeting Germany's objectives, and premiums are then adjusted accordingly. New premiums were adopted in the spring of 2004.<sup>55</sup>

The revised feed law also spells out, for the first time, how to calculate the costs for grid connection and for any necessary reinforcement of the distribution system. The new law then equitably apportions these costs to both parties: the system owners and the grid operator. The law also increases the transparency of how these costs are determined, by allowing system owners to use third-party consultants and contractors with access to all pertinent technical information to advise them whether the fees are fair.<sup>56</sup>

No other renewable energy support mechanism in the world has produced more renewable energy than the German REM.

#### **SPAIN'S REM**

Spain offers two programs: a fixed premium for projects less than 50 MW, or a bonus payment on top of the wholesale price. Nearly all of Spain's wind projects have been built using the fixed-premium mechanism. Spain, a nation of 40 million inhabitants, now closely rivals the United States in total installed wind capacity. Since 1999 Spain has installed nearly 1,000 MW of new capacity annually, often much more, and by the end of 2003 had over 6,200 MW of installed wind capacity. Spain's REM,

and its policy – not unlike the provincial policy of Quebec – of encouraging domestic manufacturing, has created a dynamic market with two indigenous manufacturers, Gamesa Eolica and Ecotecnia, as well as a host of Spanish affiliates of Northern European manufacturers. Spanish manufacturer Gamesa Eolica's strong position in the competitive Spanish market has enabled it to begin exporting to the United States.

### DANISH REM

The Danish parliament created the Danish REM system to encourage individual action toward meeting their energy and environmental policy. For two decades, Danish energy policy enabled farmers, businesses, and homeowners to install wind turbines, which they owned outright, or in which they owned a share. Danish law permitted inter-connection of wind turbines with the grid and specified the premium that would be paid for their production.

The Danish REM system provided a stable domestic market for Danish wind turbine manufacturers. The program was so successful that Danish manufacturers are now leaders in the technology and Danish wind turbines are exported around the world. Today, Denmark produces nearly 20% of its electricity with wind energy.

The REM program was scrapped in the early 2000s in favor of a certificate trading system. The poor results from

the trading system recently led to the abandonment of the program and the country may re-install an REM system.

### OTHER COUNTRIES WITH REM

In total there are nine countries in Europe and South America using renewable energy mechanisms as the principal mechanism to support renewables (Austria, Brazil, France, Germany, Greece, Luxembourg, Portugal, Spain, and the Netherlands). Countries that have recently adopted REMs include Austria and the Netherlands. Like Denmark, the Netherlands had switched from REM to a certificate trading system in the early 2000s, but they then reintroduced REM in 2004. Two more European countries are considering REMs: Italy for solar-electric systems, and the Czech Republic for wind and solar energy.

REMs are more egalitarian than almost any other support mechanism, enabling communities, cooperatives, and farmers as well as commercial renewable energy developers to participate in the rapid expansion of renewable capacity.

The fixed-premium contracts under REM reduce price volatility from utility purchases in the spot market, helping to ensure price stability.

REMs can also be an integral part of a conservation culture by instilling in consumers and the market the necessity of paying for value. Renewable energy has a higher value because of its environmental, social, and technical benefits and therefore its price should reflect this.

**TABLE 3**

Ontario's renewable energy potential for electricity and thermal applications

	Installed capacity	Electricity generation (GWh/Year)	Thermal contribution PJ/Year
<b>Wind</b>	8,000 MW (2012)	14,000	
<b>Hydroelectric (low-impact)</b>	1,000 MW (2020)	5,700	
<b>Biomass:</b>			
Electricity	2,450 MW (2010–2020)	14,700	
Thermal			114
<b>Geothermal heat pumps</b>	125,000 systems (2010)		7.7
	341,000 systems (2020)		20.8
<b>Solar:</b>			
Photovoltaic (PV) electricity	1263 MW (2025)	1,263	
Thermal	800,000 SDHW (2025)		9.6
	120,000 SPH (2025)		6.6
	420,000 new homes with SPD (2025)		85.7
	2,000 000 m <sup>2</sup> of C & I SHW (2025)		4.0
	825,000 m <sup>2</sup> SAV (2025)		7.2

Note.

SDHW = solar domestic hot water systems

SPH = solar pool heaters

SPD = solar passive design

C & I SHW = commercial and institutional solar hot water

SAV = solar air ventilation.



## 8. Conclusion and recommendations

The current government approach to deploy renewable energy in Ontario entails the high risk that only the most profitable sites (e.g. areas with the highest wind speeds) will be developed, and that only a few renewable energy technologies will be used (e.g. large wind and hydro-electric facilities, landfill gas).

Clear policies are required to ensure that all the renewable energy sources that exist throughout the province are fully tapped in a sustained and stable manner. Furthermore, smart policies are also needed to develop favourable conditions so a wide variety of participants and local organizations can actively engage in the implementation of large-scale and distributed generation systems in rural and urban areas.

The accumulated experience from the six countries leading in the worldwide adoption of renewable energy is clear: success is achieved through conscious policy decisions that create increasing demand for renewable energy technologies, ensure favourable access to the electricity grid at fair prices, facilitate low cost financing, provide tax incentives and smart subsidies, legislate standards, support education initiatives, and encourage active stakeholder participation.<sup>57</sup>

All the estimates about resource and technical potential of various renewable energy technologies are estimates based on the best available information from peer-reviewed journals, government and industry data from Ontario and other jurisdictions. While these figures are well-informed general estimates, they are not a substitute for more comprehensive analysis of the provincial renewable energy potential, and its associated economic and health benefits. The federal and provincial government should collaborate to conduct such analysis as soon as possible.

To develop Ontario's full potential of renewable energy and to ensure that the multiple benefits of renewable energy (e.g. job creation, industrial development opportunities) favours local communities, this report provides the following policy recommendations:

1. **Expand the mandate of the proposed Conservation Bureau (hereafter referred as Sustainable Energy Bureau) to include development of distributed renewable energy sources such as on-site solar, geothermal heat pumps, and biomass digesters.**
2. **Position the proposed Sustainable Energy Bureau centrally in the machinery of the OPA so that conservation, efficiency and renewable energy – the very essence of a robust electricity system – are the priorities that shape the entire agenda of the OPA. Whether this Sustainable Energy Bureau has its own board or an advisory body, it must have the authority and practical tools to influence the operation of the entire electricity system.**
3. **Mainstream grid scale renewables so that they are prioritized by the Ontario Power Authority (OPA).**
4. **Enact and negotiate stable, renewable energy mechanisms (REM) to provide specific electricity generation (kWh) payments for each renewable energy option (taking into account project location, market share, and level of technological development), and to establish and facilitate the right for renewable energy generators (REG) to connect into the electricity grid.**
5. **Implement a stable funding mechanism to finance the activities of the Sustainable Energy Bureau.<sup>58</sup>**
6. **Consolidate federal support to implement a provincial education strategy to train and certify renewable energy specialists and installers, quantify and map all renewable resources available in the province, increase public awareness on renewable energy potential and support programs.**
7. **Collaborate with the federal government in the establishment of a provincial revolving loan fund to provide interest-free loans to install distributed generation systems in farms, residences and businesses throughout the province.**
8. **Initiate a process with the federal government to quantify the environmental and social costs of all forms of electricity generation and delivery so these costs can be included into the price of each electricity option to better inform investment comparisons.**
9. **Develop a collaborative process with the largest provincial users of electricity (e.g. auto and steel manufacturers, mining companies) to establish a rational system to deal with electricity peak use.**
10. **To stimulate market transformation, direct all levels of government (provincial and municipal) to use their procurement capacity to purchase**

**their electricity needs from renewable energy sources, and to ensure that any new government-funded building incorporates renewable energy technologies for heating and cooling purposes. This strategy should be financed through new federal-provincial collaborations and should start by working with large government users of electricity such as the Toronto Transit Commission to purchase all their electricity from renewable energy sources (as is already done through Calgary Transit’s initiative “Ride the Wind”).**

As this study illustrates, Ontario has abundant opportunities to use electricity more efficiently, and an immense variety of renewable sources to satisfy its current and future power needs. Furthermore, with its industrial infrastructure and skilled workforce, the province has all the elements needed to replace its aging electricity system with a variety of sustainable options.

The next chapters of this report illustrate the vast opportunities for implementing efficiency and renewable energy strategies available in Ontario and present additional policy mechanisms to tap into these significant opportunities.

### **INDUSTRY JUMPS ON CONSERVATION BANDWAGON**

Falconbridge, a large Toronto-based mining company, has a network of energy managers identifying how the company can save consumption costs year round.

Falconbridge’s corporate goal is to reduce energy intensity by one percent per year by 2005 based on 1990 levels.

During the summer, Falconbridge shuts down its Sudbury and Trimmings smelters for maintenance and vacation – a plan that has been in place for several years.

The shutdown is timed in an effort to avoid the high-energy demand and high-cost electricity periods of the summer months. In this way, the company is better able to meet its energy cost budgets and reduces the potential impact of brownouts and

blackouts should the provincial electricity system become overloaded.

During the summer, crews continue to take ore out of the ground but stockpile it so that Falconbridge’s metallurgical plants can operate at full capacity for the remainder of the year.

To further control energy use, Falconbridge’s Sudbury Mines/Mills Energy Management Team created a tool that displays daily energy consumption in its various forms. These “daily consumption reports” help lower energy use. For example, jobs that are not time-sensitive, such as the hoisting of materials, can be shifted to hours with lower electricity rates. The reports also help identify waste, such as underground equipment running when not needed, and the use of excess compressed air.



## INTRODUCTION NOTES

- 1 In speech delivered at the Empire Club, Minister Duncan stated that Ontario faces an energy crisis and that “it needs to refurbish, rebuild, replace or conserve 25,000 MW of generating capacity by the year 2020 to meet growing demand while replacing polluting coal fired generation. That represents 80 percent of Ontario’s current generating capacity and would require an investment of \$25 to \$40 billion”. For more details see Ministry of Energy press release (April 15, 2004): “New Vision For Electricity Sector Will Mean New Supply, Increased Conservation, Stable Prices” available at [www.energy.gov.on.ca/index.cfm?fuseaction=english.news](http://www.energy.gov.on.ca/index.cfm?fuseaction=english.news)
- 2 It is a fact that natural gas-fired power plants emit lower levels of sulphur dioxide and nitrogen oxides than coal-fired plants. However, these lower emissions remain a concern, since they contribute to acid rain and ground level ozone, both of which can damage forests and agricultural crops. Ground level ozone (commonly called smog) has also been linked to a range of respiratory illnesses. More recently, ground level ozone has been linked to the development of childhood asthma, the “most common chronic disease” among children. See National Institute of Environmental Health Sciences. (2002). Multi-Sports in Ozone May Raise Asthma Risk. Press Release (January 31, 2002 available at [www.niehs.nih.gov](http://www.niehs.nih.gov)). Possibly more troubling are the emissions of fine particulates from gas-fired power plants. Though particulate emissions are about one-tenth what they are for coal power, the U.S. Environmental Protection Agency estimates that 77% of particulates from natural gas plant are of a dangerously small size.
- 3 The government of Ontario intends to retire the following coal plants by 2007 (year of installation): Lambton (1969), Nanticoke (1972), Lakeview (1962), Thunder Bay (1963 & 1982), Atikokan (1985). Ontario’s nuclear plants will all have to be retired by 2018 (year of installation): Pickering A (1971–1973), Pickering B (1983–1986), Bruce A (1976), Bruce B (1984), Darlington (1992–1993).
- 4 Reproduced from Table 1.1 page 3 of: Winfield, M.S., Horne, M., McClenaghan, T. and Peters, R. (2004). *Power for the Future: Towards a Sustainable Electricity System for Ontario*. Calgary: Pembina Institute for Appropriate Development and Canadian Environmental Law Association, available at [www.pembina.org](http://www.pembina.org)
- 5 This amounts to approximately 2,000 MW of capacity; the equivalent of the entire Pickering A nuclear generating station or enough energy to power 1,000,000 Ontario homes.
- 6 The average efficiency of generating infrastructure ranges between 30–40 percent. That is, only 30–40 percent of the potential energy in the original fuel source (coal, gas, etc.) is actually converted to electricity (the other 60–70 percent is lost as waste heat); see NRCan. (2004). *Energy Efficiency Trends in Canada*. Ottawa: NRCan. Available at [http://oee.nrcan.gc.ca/neud/dpa/data\\_e/Trends04/chapter\\_8.cfm](http://oee.nrcan.gc.ca/neud/dpa/data_e/Trends04/chapter_8.cfm)
- 7 These liabilities include construction cost overruns as well as cost overruns for repairs. For example, the Darlington nuclear plant rose from an original estimate of \$3.95 billion in 1978 to a final actual cost of \$14.4 billion. For more details see Appendix 2 of Winfield, M.S., Horne, M., McClenaghan, T. and Peters, R. (2004). *Power for the Future: Towards a Sustainable Electricity System for Ontario*. Calgary: Pembina Institute for Appropriate Development and Canadian Environmental Law Association, available at [www.pembina.org](http://www.pembina.org). The repairs of Pickering Unit 4 were estimated in 1999 to cost \$457 million and were expected to be completed by mid 2001, the actual costs totaled \$1.25 billion and were completed by September 2003; for more details see Epp, J, Barnes, P. and Jeffrey, R. (2003). *Report of the Pickering “A” Review Panel*. Available at [www.energy.gov.on.ca/english/pdf/pickering\\_report\\_dec2003\\_en.pdf](http://www.energy.gov.on.ca/english/pdf/pickering_report_dec2003_en.pdf)
- 8 Ontario Electricity Financial Corporation. (2003). 2003 Annual Report Ontario Electricity Financial Corporation. Toronto: OEFC. Available at [http://www.oefc.on.ca/pdf/oefc\\_ar\\_2003\\_e.pdf](http://www.oefc.on.ca/pdf/oefc_ar_2003_e.pdf)
- 9 OPG income before income taxes for 1999–2003 was (amounts in millions of dollars and amounts in brackets indicate liability): Pickering A unit 4 return to service (\$1571), other nuclear operations (\$1,571), fossil and hydro operations (\$50), electricity markets \$1,672, other factors \$442; for more details see Ontario Power Generation financial reports available at [www.opg.com/ir/reports.asp](http://www.opg.com/ir/reports.asp)
- 10 See Ministry of Energy press release (July 7, 2004): “Ontario Government Restarts Pickering Unit To Increase Electricity Supply” available at [www.energy.gov.on.ca](http://www.energy.gov.on.ca)
- 11 See page 49 of Manley, J., Epp, J., Godsoe, P. (2004). *Transforming Ontario’s Power Generation Company: Report from the Committee to Review Ontario Power Generation*. Available at [www.energy.gov.on.ca/index.cfm?fuseaction=electricity.reports\\_opgreview](http://www.energy.gov.on.ca/index.cfm?fuseaction=electricity.reports_opgreview)
- 12 According to Winfield et al. (op. cit. note 4, pp.2 and 48) a 1997 Ontario Hydro report titled: “Report to Management IIPA/SSFI Evaluation Findings and Recommendations” prompted Ontario Hydro to adopt its Nuclear Asset Optimization Plan (NAOP), which led to the repairs of four units at Pickering A and three units at Bruce B.
- 13 See page 30 of Winfield et al. (2004) op.cit. note 4.
- 14 See Ministry of Energy (June 24, 2004) press release: “McGuinty Government Sparks Interest In Green Electricity” available at [www.energy.gov.on.ca](http://www.energy.gov.on.ca). On April 28, the government initiated a Request for Proposals (RFP) for 300 megawatts of renewable electricity to identify interested proponents. For more details see [www.ontarioelectricityrfp.ca](http://www.ontarioelectricityrfp.ca)
- 15 Ontario’s wind figures reproduced from Canadian Wind

- Energy Association ([www.canwea.ca/en/CanadianWindFarms.html](http://www.canwea.ca/en/CanadianWindFarms.html)), and German figures reproduced from European Wind Energy Association ([www.eweaa.org](http://www.eweaa.org)).
- 16 Sawin, J.L. (2004). *Mainstreaming Renewable Energy in the 21st Century*. Washington D.C.: Worldwatch Institute. Available at [www.worldwatch.org](http://www.worldwatch.org)
- 17 For more details see page 20 of Ontario Clean Air Alliance. (2004). *Phasing Out Coal: Six Month Progress Report*. Toronto: OCAA. Available at [www.cleanairalliance.org](http://www.cleanairalliance.org)
- 18 Commission for Environmental Cooperation. (2004). *Taking Stock 2001: North American Pollutant Releases and Transfers*. Montreal: CEC. Available at [www.cec.org/files/PDF/POLLUTANTS/TS2001-Report\\_en.pdf](http://www.cec.org/files/PDF/POLLUTANTS/TS2001-Report_en.pdf)
- 19 For a summary of key epidemiological studies see page 110 of Somers, C.M., McCarry, B.E., Malek, F, and Quinn, J.S. (2004). Reduction of Particulate Air Pollution Lowers the Risk of Heritable Mutations in Mice. *Science*, 304 (May 14), 1008–1010.
- 20 Ontario Medical Association (2001). *Ontario's Air: Years of Stagnation*. Toronto: OMA. Available at [www.oma.org](http://www.oma.org)
- 21 Ibid see page 6.
- 22 According to Ontario Power Generation, in 2001 Ontario's five coal plants emitted 35.1 megatonnes (Mt) of CO<sub>2</sub>. See page 52 of Ontario Power Generation, *Towards Sustainable Development: 2001 Progress Report*, available at [www.opg.com/envComm/SED2001Report.pdf](http://www.opg.com/envComm/SED2001Report.pdf). According to the latest published government figures, Ontario's total 2001 greenhouse gas emissions were 201 Mt CO<sub>2eq</sub> (in 2001 all the automobiles and light-duty trucks used in Ontario emitted close to 35.5 Mt). For details see p.186 of Olsen, K. et al. (2003). *Canada's Greenhouse Gas Inventory 1990–2001*. Ottawa: Greenhouse Gas Division, Environment Canada. Available at: [www.ec.gc.ca/pdb/ghg](http://www.ec.gc.ca/pdb/ghg)
- 23 See IPCC. (2001). *Climate Change 2001: The Scientific Basis. Contribution of Working Group I to the Third Assessment Report of the Intergovernmental Panel on Climate Change* [Houghton, J.T., Y. Ding, D.J. Griggs, M. Noguer, P.J. van der Linden, X. Dai, K. Maskell, and C.A. Johnson (eds.)]. Cambridge: Cambridge University Press. Available at [www.ipcc.ch](http://www.ipcc.ch)
- 24 Government of Canada. (2003). *Climate Change Plan for Canada*. Available at [www.climatechange.gc.ca./plan\\_for\\_canada/](http://www.climatechange.gc.ca./plan_for_canada/)
- 25 For details see Stewart, K. (2003). *Ontario and Kyoto*. Ottawa: Climate Action Network. Available at [www.climateactionnetwork.ca/resources.html](http://www.climateactionnetwork.ca/resources.html)
- 26 For example see: European Environment Agency. (2004). *Exploring the Ancillary Benefits of the Kyoto Protocol for Air Pollution in Europe*. Copenhagen: EEA. Available at: [http://reports.eea.eu.int/technical\\_report\\_2004\\_93/en](http://reports.eea.eu.int/technical_report_2004_93/en)
- 27 For details see sections 3.69, 3.71 and Appendix C in Commissioner of the Environment and Sustainable Development. (2000). *Government Support for Energy Investment*. Ottawa: Office of the Auditor General. Available at: [www.oag-bvg.gc.ca/domino/reports.nsf/html/c003ce.html](http://www.oag-bvg.gc.ca/domino/reports.nsf/html/c003ce.html)
- 28 “Atomic Energy of Canada Limited estimated, based on the results of this program, that the cost of finding a site and constructing, operating and closing a HLW disposal facility for five million bundles of used fuel is about \$9 billion (in 1991 dollars). This estimate includes ongoing research and development on potential sites but excludes costs of monitoring the environment around the facility.” See chapter 3, Federal Radioactive Waste Management, in Office of the Auditor General. (1995). 1995 Report of the Auditor General of Canada. Ottawa: Office of the Auditor General. Available at: [www.oag-bvg.gc.ca/domino/reports.nsf/html/9503ce.html#0.2.NJDBJ2.9FBMWI.A4RLQE.W4](http://www.oag-bvg.gc.ca/domino/reports.nsf/html/9503ce.html#0.2.NJDBJ2.9FBMWI.A4RLQE.W4)
- 29 See Commissioner of the Environment and Sustainable Development. (2000). Op.cit. endnote 24 exhibits 3.33 and exhibit 3.4.
- 30 One of the few reports to incorporate environmental costs to the price of power in Ontario was conducted in 1997 and resulted in a generation price for coal power of 10 cents per kWh and for nuclear power of 15 cents per kWh. See Argue, D. (1997). *A Review of the Economic Cost of Power in Ontario*. Available at [www.newenergy.org/costofpower\\_report.html](http://www.newenergy.org/costofpower_report.html). Note that these figures are within the range of a recent evaluation, conducted by Sawin op.cit note 13, which incorporated environmental and health costs into the cost of electricity generation using European and U.S. data. Sawin's calculations resulted in a generation price for coal power of 9–29 cents per kWh and for nuclear power 13–19 cents per kWh (Sawin's original figures were converted from U.S. currency using a conversion rate of \$1 U.S. = \$0.76 CAD)
- 31 See for example Winfield op.cit. note 4 and Torrie, R. and Parfett, R. (2003). *Phasing Out Nuclear Power in Canada: Toward Sustainable Energy Futures*. Ottawa: Campaign for Nuclear Phaseout. Available at [www.cnp.ca](http://www.cnp.ca)
- 32 Winfield et al. (2004, p.37, op. cit note 4) state that capital investments of \$18.2 billion over the 2005–2020 period would be required to achieve the efficiency gains described by their research and that 96% of these costs would be recovered by consumers through the energy savings resulting from that investment.
- 33 For example, peak reductions achieved through demand response measures by large electricity users. Estimates developed for the IMO indicate that up to 10% of Ontario's peak demand could be shifted through demand response measures (DRM). About 2 percent of the province's customers (e.g. mining firms, steel and car manufactures) use about 50 percent of Ontario's power so DRM can be organized between the government and this group of large power users to improve provincial power use and to achieve industrial production gains. See Winfield, op.cit. note 4 and Bloom, R. (2004).

- Corporations keep their cool on power: As temperatures rise, big consumers plan no changes to production, *Globe and Mail* (June 29, 2004).
- 34 Reproduced from table 5.10 Winfield et al. (2004) op.cit note 4.
- 35 Bachrach, D., M. Ardema, and A. Leupp. *Energy Efficiency Leadership in California: Preventing the Next Crisis*. (San Francisco: Natural Resources Defense Council, 2002). The full report is available at: [www.nrdc.org/air/energy/eecal/eecal.pdf](http://www.nrdc.org/air/energy/eecal/eecal.pdf)
- 36 See Winfield et al. (2004) op. cit. note 5 and Torrie and Parfett (2003) op.cit. note 31.
- 37 See note 2.
- 38 Lechtenbohmer, S., Fishedick, M., Dienst, C. and Hanke, T. (2003). GHG-Emissions of the Natural Gas Life Cycle Compared to other Fossil Fuels (in Europe). *Proceedings from the 3<sup>rd</sup> International Methane and Nitrous Oxide Mitigation Conference, Nov. 17–21*. Beijing, China: Wuppertal Institute.
- 39 See, for example Energy Information Administration. 2003. "Annual Energy Outlook 2003." Electronic database accessed on April 1, 2004 at <http://www.eia.doe.gov/bookshelf/brochures/aeo2003/AEOBrochure.html>.
- 40 The U.S. added 67,000MW of gas-fired power between 1980 and 1999, and an additional 111,000MW of power is projected by 2007 in the western North America grid alone. Foley, D., Herzog, S. and Scott, G. (2001). *British Columbia at the Crossroads: Clean Energy or More Pollution?* Vancouver: David Suzuki Foundation.
- 41 Energy Information Administration. 2004. "Country Analysis Briefs: Canada." Electronic database accessed on April 14, 2004 at [www.eia.doe.gov/emeu/cabs/canada.html](http://www.eia.doe.gov/emeu/cabs/canada.html)
- 42 Ibid.
- 43 See page 13 of Wilson, F. (2001). *Who's making money on natural gas prices? What should government do?* Vancouver: Canadian Centre for Policy Alternatives.
- 44 In 2000, several events brought about an eleven-fold increase in the price of wholesale electricity, which drove up natural gas prices to record levels. True, an ill-conceived deregulation plan in California was a key reason for the increase. But with more and more jurisdictions taking the deregulation route, electricity prices – and, by extension, natural gas prices – may continue to fluctuate for Canadian utilities relying increasingly on gas-fired power. In fact, price volatility has continued, even well after the California debacle. For more details see p.4 of Bolinger, M., Wiser, R. and Golove, W. (2004). *Accounting for Fuel Price Risk When Comparing Renewable to Gas-Fired Generation: The Role of Forward Natural Gas Prices*. Berkeley: Lawrence Berkeley National Laboratory.
- 45 Ibid. p. 6–8.
- 46 For example, building a natural gas pipeline to Vancouver Island would require three new large gas-fired plants, doubling BC Hydro's greenhouse gas emissions. For more details see Jaccard, M. (2002). Gas pipeline a project deserving real public debate. *Vancouver Sun*, January 3.
- 47 One-year construction estimate based on page 6 of Canadian Wind Energy Association. (2004). *Submission by the Canadian Wind Energy Association to the Federal/Provincial/Territorial Council of Energy Ministers' Meeting July 19, 2004/Iqaluit, Nunavut*. Available at [www.canwea.org](http://www.canwea.org) Combined cycle natural gas plants can be built in about two years (for example see Ford, A. (2001). Simulation Scenarios for the Western Electricity Market: Paper for the California Energy Commission Workshop on Alternative Market Structures for California. Available at: [www.wsu.edu/~forda/bbust.html](http://www.wsu.edu/~forda/bbust.html)).
- 48 Further benefits of this approach include: modularity, short lead time, fuel diversity and reduced price volatility, load-growth insurance and load matching, reliability and resilience, local and community choice and control, avoided emissions and environmental impacts. See Dunn, S. (2002). Micropower: New variable in the Energy-Environment-Security Equation, *Bulletin of Science, Technology and Society*, 22 (2), 72–86.
- 49 Beck, F. and Martinot, E. (in print). *Renewable Energy Policies and Barriers*. Available at [www.martinot.info/re\\_publications.htm](http://www.martinot.info/re_publications.htm)
- 50 Kammen, D.M., Kapadia, K, and M. Fripp (2004) *Putting Renewables to Work: How Many Jobs Can the Clean Energy Industry Generate?* RAEI Report, University of California, Berkeley. Available at <http://list-socrates.berkeley.edu/~rael/renewables.jobs.pdf>
- 51 Canadian Wind Energy Association op.cit note 47.
- 52 Hélimax. (2004). *Étude sur L'Évaluation du Potentiel Éolien, de son Prix de Revient et des Retombées Économiques Pouvent en Déouler au Québec, Dossier R-3526-2004*. Montreal: Hélimax. Available at [http://www.helimax.com/dossier\\_r35262004.pdf](http://www.helimax.com/dossier_r35262004.pdf). For 1,000 MW: 6.7 person-years/\$1 million; 121.5 person-years/TWh for operation. For 4,000 MW: 7.7 person-years/\$1 million; 107.9 person-years/TWh. Note: it is not explained in the text why there would be more people employed per dollar invested at 4,000 MW than 1,000. Assuming 4,000 MW installed at the rate of 1,000 MW/yr and operating for 25 years, the German employment values would produce about 97,000 person-years, versus the Helimax's estimate of 78,000 person-years.
- 53 The Bonneville Power Authority currently offers two systems to support wind power using hydroelectricity: a network wind integration service and a storage and shaping service; for details see [www.bpa.gov/Power/PGC/Wind/wind.html](http://www.bpa.gov/Power/PGC/Wind/wind.html)
- 54 See graphic 2 press release of European Wind Energy Association (March 10, 2004): "Record euro \$8 Billion of wind power installed globally in 2003" available at [www.ewea.org/04media/press.asp](http://www.ewea.org/04media/press.asp)
- 55 REMs in the new EEG cover wind, solar photovoltaic in several different applications, hydro plants of various sizes, several forms of biomass, and geothermal plants of

various sizes. For the actual mechanisms see <http://www.ontario-sea.org/REMs/GermanREMs2004.xls>

- <sup>56</sup> For an explanation of how the German mechanisms came into effect and how they are applied see Wilson Rickerson, German Renewable Energy Feed In Tariffs Policy Overview, <http://www.ontario-sea.org/REMs/REMsRickerson.html>
- <sup>57</sup> For the past decade six countries: Denmark, Germany, India, Japan, Spain and the United States have achieved 80 percent of the world's wind and solar installation through policy mechanisms that address these factors (Sawin, op.cit. note 16).
- <sup>58</sup> Some viable options for stable funding include: developing a public benefit fund based on a 0.3 cent surcharge in each kWh sold in the province; levying a carbon tax on electricity generated by fossil fuels (as it is done in the Netherlands). For more information on the funding alternatives currently used in the U.S. see [www.cleaneenergystates.org/Funds/](http://www.cleaneenergystates.org/Funds/)



# 2

## Wind Power in Ontario

### Summary

**WORLDWIDE EXPERIENCE SHOWS THAT** by investing in and developing wind power, Ontario will help create a more stable and reliable electricity system, a cleaner environment and new economic opportunities.

There is no comprehensive wind resource assessment of Ontario. New digital maps are being prepared, but they were not ready in time for this study. However, using accepted estimating techniques and the performance of wind turbines operating in similar wind regimes in Germany, a significant wind resource has been identified. The technically achievable wind resource in Southern Ontario is 86 TWh annually, or about 58% of current provincial consumption.

Based on European experience, especially that of Germany and Spain, Ontario could install as much as 8,000 MW of wind-generating capacity by 2012. This is more ambitious than the tender by Quebec for 1,000 MW of wind capacity, but it is in line with the pace of current European development. This fleet of wind could generate 14 TWh annually, or about 10% of current consumption.

Using the same assumptions as a recent economic impact study of Quebec's 1,000 MW tender for wind-generating capacity, 8,000 MW of wind capacity installed in Ontario could produce nearly \$14 billion in economic activity and 97,000 person-years of employment.

Despite a modest wind resource, Germany is the world's wind energy powerhouse. Wind turbines in Germany are capable of generating more than 28 TWh per year, the equivalent of nearly one-fifth of Ontario's current electricity consumption. Germany has a dynamic and competitive market for wind energy because of its

renewable energy mechanisms. These mechanisms eliminated two of the most important obstacles inhibiting wind development: the ability to connect to the grid, and a firm premium for an extended period of time to warrant the financial risk of investment.

German renewable mechanisms pay one price for wind turbines in windy areas, and higher prices for turbines located at less windy sites. This is intended to avoid the concentration of wind turbines in only the windiest locales and ensure that wind turbines are distributed across the country.

Currently there are no renewable mechanisms in Ontario and the province has launched a tendering system instead of renewable mechanisms. Analysis of existing experience shows that tendering systems have not succeeded in creating dynamic markets.

### 1. Background on wind energy<sup>1</sup>

Wind energy is one of the most successful of the new renewable technologies developed during the latter part of the 20th century. From humble beginnings as the darling of backyard tinkerers and anti-nuclear activists in Denmark in the late 1970s, Danish technology leapt the Atlantic and fueled the great California "wind rush" of the early 1980s.<sup>2</sup> Though not without its technological and commercial setbacks, the wind industry has continued to grow and prosper over the intervening two decades.

#### 1.1 WORLDWIDE WIND DEVELOPMENT<sup>3</sup>

At the end of 2003 there were 40,000 megawatts (MW) of commercial wind-generating capacity operating worldwide, some three-quarters of that in continental Europe.<sup>4</sup>



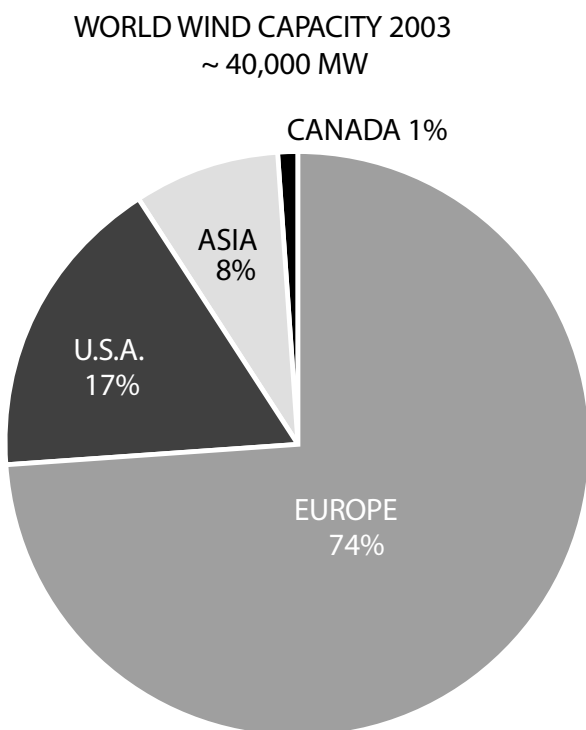

**FIGURE 1** World wind capacity. Wind energy is growing rapidly worldwide with most of the growth taking place in Europe. About three-quarters of the world's wind generating capacity has been installed in the densely populated countries of continental Europe, notably Germany, Spain, and Denmark. Despite its size, wealth, and early start in wind energy, the U.S. accounts for less than one-fifth of the world's wind capacity.

By contrast, North America with a much greater land mass and a lower population density than Europe, accounts for less than one-fifth of total world wind capacity. Nearly 8,000 MW of new wind capacity was installed in 2003 alone.

Nearly 300 MW were installed offshore in 2002 (equivalent to almost all of Canada's installed capacity). Most of that was in Denmark, but there were some 20 MW installed off the Dutch and the Swedish coasts. Altogether, offshore installations accounted for 3% of the world market in 2002. By 2007 offshore wind is expected to account for 14% of the world's new wind capacity.<sup>5</sup>

The technological and commercial development of offshore wind projects in Danish, British, Irish and German territorial waters may have a profound effect on wind development in Ontario. With the province's 1,500 km of shoreline along the Great Lakes and the shallow waters offshore, there is significant potential for development in this area. Typically, offshore projects are more expensive to develop than sites on land. However, the greater unobstructed winds available offshore and the

reduced turbulence over water combine to produce greater yields than found on land nearby. In addition, the province already owns all rights for development offshore which can greatly facilitate offshore wind installation.

## 1.2 WIND ENERGY IS A MATURE BUSINESS

Wind energy has become a multi-billion dollar industry. In 2003, total revenues from the sale of wind-generated electricity, wind turbines, towers, and development services reached nearly \$28 billion.

The Canadian Wind Energy Association (CANWEA) estimates that installing 1 MW of wind power in Ontario currently costs \$1.5 million.<sup>6</sup> The largest project installed to date is the 9 MW array of five turbines at the Bruce nuclear plant; however, no data is publicly available on the actual cost of the project. The German wind energy association reports average installed costs across the German wind sector of \$1.9 million per installed MW of wind power.<sup>7</sup>

The cost of installed wind generation has dropped remarkably during the past two decades partly by economies-of-scale as the turbines have become larger, and partly by learning how to build, install, and operate wind turbines more effectively.

In the 1990s, the cost for of turbines fell by nearly 20% for every doubling of the number of wind turbines manufactured.<sup>8</sup> During the late 1990s, the production of commercial-scale wind turbines doubled almost every three years.

## 1.3 TECHNICAL CONSIDERATIONS

### 1.3.1 INTEGRATION

Some utilities have been reluctant to consider wind energy as a significant new source of generation because of concerns about the quality of the power produced, the difficulty of regulating wind's variable generation, and confusion about the true value to the utility of wind generation. Some utilities worry that wind energy, because it is intermittent, is "unreliable" and is not able to provide firm capacity.

On the surface, it appears that a resource that cannot be controlled at will threatens the reliability of an integrated electric utility. Fortunately, a better understanding of wind technology is overcoming the concern about wind energy's intermittency – what to do when the wind stops blowing. Although wind power technology has surpassed institutional knowledge, the idea lingers.

That is, according to conventional wisdom, utilities would still need the same amount of generating capacity with or without wind power plants, because the wind is intermittent, or it is sometimes unavailable when most needed.

### 1.3.2 CAPACITY CREDIT

Although wind turbines may be idle due to a lack of wind at times of a utility's peak demand, there is a statistical probability that they will be available, especially if there are multiple wind turbines dispersed geographically across a region. In this, wind turbines are no different from conventional power plants. No generating plant operates 100% of the time, and no power plant is 100% dependable during peak loads.

The work of engineers on both sides of the Atlantic has refuted the notion that wind energy cannot supply some degree of dependable power.<sup>9</sup> The question becomes not if there is any capacity value in wind energy, but what is its value in offsetting the construction of conventional capacity.

Utilities traditionally have viewed wind energy solely as a fuel saver.<sup>10</sup> Each kilowatt-hour generated by a wind turbine offsets a kilowatt-hour that would have been otherwise generated. But in some cases, the capacity value of wind energy to a utility is equal to that of the fuel it offsets.<sup>11</sup>

Moreover, in some locales there is a good fit between the wind resource and the load. One study for Pacific Gas & Electric Company found an exceptional match between the wind resource in California's Solano county and demand justified a capacity credit nearing that of a conventional fossil plant based on a loss of load analysis. Using the same analysis, the utility found a lesser, but not insignificant, value for the Altamont Pass. The capacity credit for the Altamont Pass was found to be surprisingly similar to the area-wide capacity factor.<sup>12</sup>

In a recent report the California Energy Commission examined the capacity value of several sources, including wind energy. The report concluded that the capacity credit for wind energy is significantly lower than conventional resources, "but shows that wind can help reduce system risk. . .the wind capacity credit values are consistent with what we would find for a conventional unit with a very high forced outage rate of about 75%."<sup>13</sup>

European studies have found that up to 20% of demand could be supplied by wind energy without changes to the existing transmission and regulation system.<sup>14</sup>

### 1.3.3 PENETRATION

There are several regions of northern Europe where existing wind generation exceeds 20% of supply annually. Wind supplies nearly 20% of Danish electricity and during windy winter months the contribution is even higher. In some coastal states of Germany, wind's contribution exceeds 20% and in the county of Ostfriesland, wind accounts for more than half of annual supply. In some areas of Europe, wind turbines are net exporters of electricity.

### 1.3.4 SEASONAL MATCH WITH LOAD

There is good seasonal and diurnal match between wind and load in Ontario. Peak seasonal winds occur in winter during the heating season, and in mid afternoons during the summer cooling season. Winter winds are further complemented by the substantial increase in air density of colder air.<sup>15</sup> Seasonal wind resources are predictable enough to make seasonal commitments for displacement of fossil fuels. That is, system planners can, with some degree of reliability, plan seasonal dispatching that includes wind energy.

### 1.3.5 COMPATIBILITY WITH HYDROELECTRIC STORAGE

Wind turbines installed in a modest wind regime such as Ontario will be operating above the cut-in wind speed (i.e. the speed at which wind turbines first start generating electricity), and producing some amount of electricity for more than 6,000 hours per year. At Ontario's more energetic sites, wind turbines will be in operation more than 7,000 hours per year.<sup>16</sup>

Wind, like hydropower, is subject to the vagaries of climate. However, seldom is there a poor wind and a poor hydro year simultaneously. Wind energy is seen as complementary to hydro-electricity systems with some storage. During periods of peak wind and low demand, wind offsets hydroelectric generation and water can be stored behind the dam for release during periods of higher demand.<sup>17</sup>

Wind energy is a local resource, not subject to supply interruptions or depletion. Further, wind energy offers stable long-term prices because there are no fuel costs. Ontario has a long tradition of using hydroelectric generation and planners intuitively understand the benefits of local control of an indigenous resource.

Chapter three elaborates in detail how to take advantage of this potential.

## 1.4 BENEFITS OF WIND ENERGY

The benefits of using wind for electricity generation are numerous.<sup>18</sup> Wind energy creates new jobs, offsets emissions from fossil-fired power plants, offsets external costs, provides net positive energy balance, stimulates new economic development, notably in rural areas, enhances security of electricity supply, and provides electricity price security. Analysis of all of these benefits is beyond the scope of this chapter and therefore we concentrate here solely on job creation and economic development.<sup>19</sup>

### 1.4.1 EMPLOYMENT

Ontario is the industrial center of Canada and has the infrastructure and the skilled workforce needed for manufacturing wind turbines, towers, and their electrical components. Towers are a feasible near-term product for Ontario domestic manufacturing. Towers can account for one-fifth of the installed cost and constitute a good fit with Ontario's steel industry. However, if adequate policy mechanisms are not implemented, provincial employment from developing Ontario's wind resource will be affected by competition within the North American market.

Quebec has announced an interest in a 1,000 MW tendering program to develop wind energy in the province. While not as aggressive as the development program suggested here (8,000 MW in Ontario by 2012), Quebec is wooing manufacturers to locate in the province.

To visualize the employment potential consider that Germany has currently over 45,000 people working in its wind industry (37,000 direct and indirect manufacturing jobs in the German wind industry and another 8,000 additional jobs servicing wind turbines).

Taking the German employment experience, and the accelerated development of wind energy in Europe, it is possible to forecast the potential effects on job creation in Ontario. Assuming that installed costs will likely be lower in Canada than in Germany, the employment effect per megawatt of capacity will potentially be lower than in Europe as well.

Nevertheless, it is possible to estimate the number of people that would be directly and indirectly employed in the manufacturing sector by a build-out that begins modestly at 300 MW in the first year, reaches 1,000 MW per year within five years, and peaks at 2,500 MW in the eighth year. If Ontario's wind development evolves like Germany's and Spain's, there could be nearly 100,000 person-years of cumulative employment by 2012. For comparison purposes this figure can be converted into total jobs per MW by averaging this type of employment over the life of the wind facilities.<sup>20</sup>

A recent study of the economic impact of developing wind energy in Quebec used estimates of the jobs created by manufacturing and installing wind turbines quite similar to those used here. The Quebec study examined job creation over the 25-year life of a wind project and

**TABLE 1**

Potential Employment Creation from Ontario's Wind Development (person-years)

(Derived from Experience in Germany)

	MW Installed	MW Cumulative	\$CAD Installed Cost	\$CAD Operations Cost	Manufacturing Jobs (4)	Service Jobs (5)	Total
Phase 1 (1)							
2005	300	300	450,000,000	16,200,000	3,150	162	3,312
2006	500	800	750,000,000	43,200,000	5,250	432	5,682
2007	500	1300	750,000,000	70,200,000	5,250	702	5,952
2008	700	2000	1,050,000,000	108,000,000	7,350	1,080	8,430
Phase 2 (2)							
2009	1000	3000	1,500,000,000	162,000,000	10,500	1,620	12,120
2010	1000	4000	1,500,000,000	216,000,000	10,500	2,160	12,660
Phase 3 (3)							
2011	1500	5500	2,250,000,000	297,000,000	15,750	2,970	18,720
2012	2500	8000	3,750,000,000	432,000,000	26,250	4,320	30,570
				<b>Person-years</b>	<b>84,000</b>	<b>13,446</b>	<b>97,446</b>

NOTES

(1). 2,000 MW installed within 4 years.

(2). 4,000 MW total installed capacity within 6 years.

(3). 8,000 MW total installed capacity within 8 years.

(4). 7 jobs/\$ million CAD, \$1,500 CAD/kW

(5). 10 jobs/\$ million CAD, \$54 CAD/kW

thus encompasses a much longer time frame than used in our analysis.<sup>21</sup>

Comparing our projections with those of the Quebec study for 4,000 MW over 25 years, our estimates are somewhat higher, but not overly so considering the range of uncertainties.<sup>22</sup>

#### 1.4.2 ECONOMIC DEVELOPMENT

**Direct and indirect economic benefits:** Helimax's study examined the economic results from a commercial wind development program and estimated the value added for manufacturing, installation, and operation of 1,000 MW of wind capacity for 25 years. The study estimated that there were \$590 million in direct benefits to the Quebec economy if a major portion of the wind turbines and their components were sourced in Quebec. There were an additional \$800 million in indirect benefits and the program created another \$280 million in economic activity for a total of \$1.7 billion in economic benefits over the life of the project.<sup>23</sup>

Using the Helimax assumptions, installing 8,000 MW in Ontario in a phased program by 2012 could generate nearly \$14 billion in economic activity in the province. Helimax's most important caveat was the assumption that 50% to 60% of the value added in building the 1,000 MW was sourced in Quebec.

If both Quebec and Ontario aggressively develop wind energy, they will compete for wind turbine manufacturers and their suppliers (towers, for example) to locate in their respective province. The majority of manufacturing jobs will most likely go to the province that the industry believes has the most serious and long-lasting commitment to installing a significant amount of capacity. Ontario is a new and potentially very large market that can lure manufacturers to the province. It is not yet too late to act.

Quebec appears to be seeking one manufacturer for a limited potential market of 1,000 MW over a period of several years. The manufacturer selected will expect to also sell into other provinces and into the U.S. market to make up for the quota-driven Quebec market. By using a quota and tendering system, Quebec sends a signal that it is not seeking a dynamic market of suppliers, but a captive manufacturer who will provide a certain number of jobs in a depressed region.

Ontario can choose to create a dynamic market served by several manufacturers located in the province if there are no limits on the capacity installed annually, that is, by not setting quotas through the Request for Proposal

or tendering process. By creating a market that has the potential to exceed 300 MW, 500 MW, or even 1,000 MW per year, Ontario can lure European manufacturers to the province where they can compete to win greater shares of an expanding market. Such a competitive market provides more jobs more quickly than through tendering to one or two captive suppliers.

**Co-location:** Wind turbines can co-locate with most existing land uses. Thus, wind turbines offer landowners, whether rural or urban, commercial or industrial, an opportunity to produce a new cash stream on their property. The wind turbine installed at Exhibition Place by the Toronto Renewable Co-op and Toronto Hydro was the first in North America to demonstrate that wind energy can be located within urban areas. There are many such examples in Europe, including Copenhagen, the capital of Denmark.<sup>24</sup>

Far more significant, however, is the opportunity to use wind turbines in rural Ontario where they can co-exist with crops or pasture.

**Rural economic development:** Wind turbines have provided a new cash crop for farmers in Denmark and in Germany and states such as Iowa and Minnesota. They can do the same for farmers in Ontario.

Wind energy can benefit farmers in two ways. Farmers can lease their land to a wind developer, or farmers can install, own, and operate the wind turbines themselves. Under existing Ontario policy, farmers and small landowners in general are discouraged from supplying electricity to the province.<sup>25</sup>

**Leasing:** Royalties on land leased to commercial wind developers offer farmers the lowest risk means for benefiting from wind energy. The developer bears almost all of the business risk.<sup>26</sup> Farmers can continue doing what they do best – farming. They leave wind development to the wind developers.

Wind leases offer farmers less rewards than if farmers owned the wind turbine directly. Royalties on land leases range from 2% on gross revenues to as high as 5% during the first ten years, up to 6% during the second ten years, and as high as 8% during the third decade.<sup>27</sup> Royalties can accrue on all gross revenues and not solely on the sale of electricity. Some projects sell their green benefits for almost as much as they sell their kilowatt-hours of electricity. Developers may also offer signing options of up to \$1,000 and installation bonuses of \$2,500 /MW.

Depending upon the price per kWh and the amount generated, a leaseholder could receive \$2,500 to \$13,000 per MW per year. During the twenty-year life of a wind turbine, farmers with a 1-MW turbine on their land could earn from \$50,000 to \$250,000 per MW of installed capacity.<sup>28</sup>

A 1-MW turbine would require an area clear of other wind turbines of about 28 hectares. That is, if there were more than one wind turbine, each would occupy an area of open space that permits unhindered access to the wind. However, each turbine uses only 1% to 5% of the land occupied for roads, substations, and ancillary structures.

**Owning:** When farmers or landowners own a turbine they bear all risk themselves, including technical risk, wind risk, and political risk.<sup>29</sup> However, all profit then accrues to the farmers or landowners.

If farmers own their own 1-MW turbine and they received \$0.075 to \$0.1 per kWh generated, they could earn \$100,000 to \$225,000 per year in net revenues in Ontario. Once the debt is retired, from ten to fifteen years, the farmer could expect to earn \$500,000 to more than \$2 million during the twenty-year life of the turbine.

While not risk-free, wind turbines have the potential to more than double farm income for those farmers capable of taking advantage of the opportunity. And all wealth generated by farmer-owned, or locally-owned wind turbines flows from Ontario electricity consumers directly to provincial communities.

Consider a hypothetical case where one-half of Ontario farmers installed one 1-MW wind turbine. The 27,000 MW installed could generate about one-third of Ontario's current consumption. Using the assumptions above, these wind turbines could pump from \$3.5 to \$4.5 billion through Ontario's rural economy.

Some 30% of Ontario farms have sufficient land area for two 1-MW turbines. Another one-third of Ontario farms have enough surface area for four 1-M turbines. There are 1,000 farms in Ontario with a working area of approximately 400 hectares. Each farm of this size could, in theory, absorb ten 1-MW turbines for 10,000 MW of capacity. The benefits from wind energy for rural Ontario are potentially quite significant.

## 2. Ontario's wind resource: waiting to be discovered

At the time of writing there were no detailed maps of Ontario's wind resource. However, modern digital maps

using existing wind data and computer simulation are being prepared, and the Canadian unified mesoscale wind energy atlas prepared by Environment Canada will be released in the fall of 2004.

Early mapping of regional wind resources was based on informed extrapolation of airport data typically measured below 10 metres (m) up to 50, 80 or 100 m above the ground. Much of the wind data available in North America, prior to wind development, was from airport meteorological stations. Data from these stations is often suspect, because the measurements are made on short masts, and are typically unrepresentative of what wind turbines would encounter at 50 to 100 m above ground level.

Modern wind turbines use extremely tall towers. The 1.8 MW wind turbines operating in Ontario are at a hub height of nearly 80 m. Towers more than 100 m tall are not uncommon in Europe. Tall towers elevate wind turbines well above the effects of trees, buildings, and other obstructions that retard the flow at meteorological stations on short masts. The tall towers experience a much better wind resource than airport meteorological stations, and often do much better than projected using standard methods of estimating increases in wind speed with height above the ground.

Another source of wind data are meteorological stations. However, the reliability of this data is compromised by the fact that many Canadian meteorological stations are specifically located for agricultural measurements, particularly precipitation, and therefore they are deliberately located in areas where precipitation measurements are not disturbed by winds.

Detailed wind resource assessments conducted over a period of years are imperative to identify areas with the best wind resources.<sup>30</sup>

Contrary to classic economic geography, wind energy development is only indirectly related to the wind resource. Much of the world's wind development has taken place in regions of only modest wind resources. The location, pace, and amount of wind energy development is more directly a function of government policy and incentive mechanisms, than wind resource. This assertion is best illustrated by the contrast between Germany and Great Britain. Germany, by international standards, has a modest wind resource. Britain, on the other hand, has one of the world's best. Yet in 2003 there were more than 14,000 MW of wind-generating capacity operating in Germany and only 650 MW in Britain.

While the early expansion of wind energy in the windy mountain passes of California and along the windswept coastline of Denmark may seem to contradict the previous statement, because they followed traditional development patterns, this is not the case upon close examination. During the early 1980s, a period of rapid expansion of wind energy in California and Denmark, both locations provided a supportive political environment – and most importantly – mechanisms that guaranteed a favourable fixed premium for the wind-generated electricity. With the fixed premium, and in the case of California, with substantial tax subsidies in hand, developers could easily obtain the capital needed to develop large wind projects, leading to the California “wind rush” that lasted from 1981 through 1985.

Denmark followed a different development pattern than California. In Denmark wind turbines were installed singly or in small clusters rather than in large wind power plants. Like California’s developers, Danish farmers and cooperatives were able to find financing for their purchase of wind turbines because of the guaranteed premium and the ability to offset environmental taxes on fossil-fired generation.

**2.1 ESTIMATING ONTARIO’S WIND RESOURCES**

**TOTAL RESOURCE**

Even by North American standards, Ontario has a huge surface area of about one million km<sup>2</sup>. Assuming a modest average wind resource of 5 m/s, there is 14,000 TWh of wind energy coursing across the province every year (Ontario currently uses about 150 TWh of electricity annually).<sup>31</sup>

**2.2 TECHNICAL RESOURCES**

The theoretical maximum amount of wind energy that can be extracted from the wind, is 8,000 TWh. In actual operation, most wind turbines deliver far less for a host of reasons, including the interference of one wind turbine with another in a geometric array. Assuming a very open spacing between turbines of eight diameters across the wind by ten diameters downwind (8 RD x 10 RD), there is technically 5,000 TWh available per year across the entire province.

**2.3 PRACTICAL RESOURCE**

Ontario’s population and electrical load are concentrated in the southern portion of the province. Partly as a result, the transmission system is also concentrated in southern Ontario. The Canadian Wind Energy Association

**TABLE 2**

Wind resource potential in Ontario

	TWh/yr	% of 2001 Demand <sup>6</sup>
Total Resource <sup>1</sup>	14,000	9524%
Technical Resource Betz Limit	8,000	5442%
Technical Resource <sup>2</sup>	5,000	3401%
Practical Resource <sup>3</sup>	1,500	1020%
Accessible Resource <sup>4</sup>	90	61%
Acceptable Resource <sup>5</sup>	45	31%

<sup>1</sup> 5 m/s @ hub height, 100 m<sup>2</sup> land area/m<sup>2</sup> rotor swept area, province wide.

<sup>2</sup> 00 kWh/m<sup>2</sup>/year annual specific yield.

<sup>3</sup> Southern Ontario only @ 500 kWh/m<sup>2</sup>/year annual specific yield.

<sup>4</sup> One 1-MW turbine per farm; 55,000 farms in Ontario; 600 kWh/m<sup>2</sup>/year annual specific yield; 2,800 m<sup>2</sup>.

<sup>5</sup> 1/2 the Accessible Resource.

<sup>6</sup> 147 TWh/yr in 2001 total Ontario consumption.

estimates that there are 300,000 km<sup>2</sup> within reach of the existing transmission system, roughly corresponding to southern Ontario.<sup>32</sup> For comparison, southern Ontario is about the same size as Germany, yet with about one-sixth the population density.

Limiting the practical wind resource to southern Ontario only, and using the same assumptions on spacing and wind resource as that for the entire province, there is the potential for 1,500 TWh or 10 times the province’s 2001 electricity consumption.

**2.4 ACCESSIBLE RESOURCE**

Without digital data for roads, buildings, parks, wildlife sanctuaries, airports, military bases, First Nations, and other areas where wind development may be prohibited, it is difficult to estimate how much accessible wind resource exists in southern Ontario. However, it is possible to use farmland as a representative surrogate for culturally and politically accessible land areas where wind energy may be permitted.

Farmland represents a working landscape where farmers and the public accept the use of structures and



FIGURE 2 Renewable energy mechanisms (REMs) are essential to enable farmers to benefit directly from wind developments.

mechanical devices on the land. Farmers and the public also expect that farmland will be “tilled” in some manner that requires breaking the soil, growing crops, and harvesting. Farmland is thus not a static landscape. There are seasonal cycles of activity, which reach a peak in spring and fall. Wind turbines are already a common rural feature in many European nations such as Germany, Denmark, and the Netherlands.

Ontario’s Ministry of Agriculture and Food lists 85,000 farm operators in the province; however, the Ontario Federation of Agriculture estimates there are only 55,000 individual farms. By definition, these farms are all accessible by road and farm equipment. They may not be accessible to transmission lines of sufficient capacity, but they are all likely served by a distribution line of some capacity.

For illustrative purposes, if every farm installed one 1-megawatt wind turbine with a rotor 60 metres in diameter, and there was a slightly more robust wind resource than that province wide, farming the wind in this manner could generate 90 TWh per year, or nearly two-thirds of the province’s consumption.

## 2.5 ACCEPTABLE RESOURCE

Farmers once relied upon wind turbines for irrigation and are again making wind turbines a commonplace feature of the agricultural landscape. One need only travel to Denmark to see how distributed wind turbines have become an integral part of the rural Danish landscape.

It is safe to assume that many of Ontario’s farms are not suited for wind development, and that some farmers may not want wind turbines on their property. Furthermore, land use policies may preclude large areas of farmland from consideration.

Again, for illustrative purposes only, assuming that one-half of Ontario’s farms could install one 1-MW turbine, or about 27,500 MW, there is still the potential to deliver 45 TWh per year or about one-third of Ontario’s total consumption.

Of note is a comparison of this crude technique with data results from a 1991 study of Ontario’s wind potential. Examining actual wind data for meteorological stations in southern Ontario, the study tallied the amount of developable land area in each of several wind classes after excluding a portion in each for potential land use conflicts. The study concluded that there was sufficient land area to potentially develop a total of 24,000 MW.<sup>33</sup>

A recent review of this 1991 study using current methods found the main conclusions to still be valid.<sup>34</sup>

## 2.6 ONTARIO’S ACHIEVABLE WIND CONTRIBUTION

There are several ways to estimate what wind capacity is realistically achievable in the province. One method looks at jurisdictions elsewhere and what they have achieved; while another method examines the pace at which others are adding new wind generating capacity. First consider the case of Germany’s Ostfriesland county and then that of Germany as a whole.

In 2002 there was 540 MW of wind capacity operating in the county of Ostfriesland in Germany’s northern state of Niedersachsen. Ostfriesland has a surface area of 3,300 km<sup>2</sup>, about one percent that of Germany, and somewhat less than one percent of the surface area of southern Ontario.<sup>35</sup>

Wind development in Ostfriesland continues to expand. The installed capacity will continue to increase for the foreseeable future, but at a more modest pace than in the 1990s. Even so, the capacity installed in 2002 is a good marker for comparison.

If southern Ontario, with almost 100 times the surface area, were to install as much wind capacity as Ostfriesland in 2002, there would be nearly 50,000 MW of new wind generation in the province. Even assuming a conservative annual specific yield of 600 kWh/m<sup>2</sup>/year for such an extensive fleet, wind turbines in Ontario of the density now found in Ostfriesland could generate nearly 90 TWh or slightly less than 60% of total electricity consumption in Ontario.

In 2003, the 15,000 wind turbines operating in Germany were expected to produce 18.6 TWh (for comparison, about 15 commercial-scale turbines were operating in Ontario in 2003.)

As in the case of Ostfriesland, Germany continues to develop wind energy. Industry analysts expect Germany to reach 20,000 MW by 2006. If the German offshore market develops as expected, Germany could reach 30,000 MW of wind capacity by 2012.

If Ontario were able to install a similar size fleet of wind turbines delivering the same amount of generation as that of Germany in 2003, wind turbines in the province would produce 18.6 TWh per year or 13% of the province’s electricity use.

## 2.7 GROWTH QUICKENS IN NEW MARKETS

Ontario has limited experience with wind energy. There are many obstacles to rapid deployment. Nevertheless, experience in Europe indicates that markets new to wind

energy take up the technology much more quickly than previous markets. The reasons are two-fold: greater accumulated experience, and larger turbines. New markets need not make the same mistakes as those that went before. New markets begin further along the learning curve than those that pioneered the technology. The turbines are more reliable, more productive, and far more cost-effective today than those of only a decade ago. Wind turbines of the mid-1990s were 500 kW in size today's machines are three or more times larger.

It took Denmark 16 years to install 2,000 MW of wind capacity, Germany seven years. Spain, a relative newcomer, took only five years. In recent additions, Germany took less than two years to install an additional 2,000 MW as did Spain. Germany installed 3,250 MW in 2002 alone.

Based on European experience, Ontario could emulate Spain in the installation of its first 2,000 MW within four years of program initiation by using today's larger, more productive wind turbines. Ontario could conceivably add an additional 2,000 MW by 2010 and double the 4,000 MW installed within two more years, reaching 8,000 MW by 2012.

Assuming the same annual specific yield as in the previous example, Ontario wind turbines could generate 7 TWh by 2010 (5% of total current provincial consumption), and 14 TWh by 2012 (10% of total current consumption).<sup>36</sup>

Regardless of how the wind resource of Ontario is viewed, the potential is significant and can make an important contribution to Ontario's current generating mix.

### 3. Policies, mechanisms, and incentives to enhance wind power implementation

In nearly all jurisdictions worldwide, wind turbines operate under some kind of policy or support mechanism designed either to redress an imbalance in the marketplace, or to stimulate the rapid development of what is considered a desirable technology. Two key elements of any program are the ability to interconnect the wind turbines with the grid and some form of financial support or payment through power purchase agreements.

Various financial support mechanisms such as direct financial support (e.g. subsidies), politically set quotas (renewable portfolio standards or RPS); politically set prices (European renewable energy mechanisms or



FIGURE 3 Policies that enhance stakeholder involvement are crucial to ensure active community participation in wind projects

REMs) have been used with varying degrees of success. The potential and limitations of these mechanisms is discussed in the next sections.

#### 3.1 PUBLIC UTILITY REGULATORY POLICIES ACT

The U.S. Public Utility Regulatory Policies Act (PURPA) is an early example of policy that tried to address both the right of interconnection and the right to a power purchase agreement. PURPA was part of the 1978 National Energy Act passed by the United States Congress. Though multifaceted, PURPA is most widely known for requiring utilities to buy power from, and sell power to, cogenerators and small power producers, the term then used for wind turbines and other forms of alternative energy. Unfortunately the rate, or price, was never specified. PURPA only described the method for calculating it. This resulted in lengthy legal challenges and regulatory rule-making that effectively stymied the hoped-for benefits of PURPA.



### 3.2 STANDARD OFFER CONTRACTS

Wind turbines are capital-intensive, long-lived forms of generation with no fuel costs. As such, investors and banks need to be assured that there is a market for the wind-generated electricity at a predictable price to justify the technical, meteorological, and political risks they assume when financing a wind project of any size.<sup>37</sup>

While a few wind turbines had been installed under PURPA in the United States, there was no large-scale wind development until the California Public Utility Commission (PUC) used its power to authorize standard contracts between developers of alternative energy and private electric utilities.<sup>38</sup> Some standard contracts offered spot-market prices.<sup>39</sup> One, Standard Offer No. 4 (S.O.4), offered fixed prices for a fixed number of years. Unfortunately, the PUC placed a limit on how long the new S.O.4 contracts would be offered, resulting in a rush of applications and attendant speculation. Nevertheless, the S.O.4 contracts, coupled with lucrative tax subsidies, resulted in the development of 1,500 MW of wind-generating capacity that produces about 3 TWh year; 1% of California supply, or the equivalent to 2% of Ontario's demand. And these wind turbines have been doing so for nearly two decades.

### 3.3 DIRECT SUBSIDIES

Direct subsidies based on the amount of generating capacity installed were the mechanism of choice in the Netherlands and the United States during the 1970s and early 1980s. These subsidies were widely abused, provided little incentive to generate electricity, and did little to encourage development of the technology.<sup>40</sup>

Subsequently, the United States adopted a federal Production Tax Credit (PTC) in 1992. The PTC is a credit against federal tax liabilities and in its present form is not transferable, that is, it cannot be passed through to limited partners. The equity owners must have the tax liability to take advantage of the credit. Thus, the PTC is useful only to the largest companies in the United States. Moreover, the PTC has a sunset provision and its expiration and eventual Congressional reinstatement have led to numerous "boom and bust" cycles in the U.S. wind industry.

There is an associated subsidy for publicly owned utilities in the United States, but the subsidy is subject to annual Congressional appropriations and is often oversubscribed.

Neither program has led to a stable domestic market for wind energy.

The Wind Power Production Incentive (WPPI) is the Canadian federal equivalent of the PTC. WPPI is lower in value than the PTC but is more egalitarian. Unlike the PTC, WPPI is a payment, not a tax credit. As such, WPPI is a more direct mechanism than the PTC. Unfortunately, use of WPPI triggers federal environmental review, increasing the cost, complexity, and length of time needed to develop a project, even if only one turbine is involved.

WPPI was implemented in 2002 and has a program life through 2007. Unlike the PTC, Canada's WPPI has a 1,000 MW limit or cap and would therefore be of limited use for a large wind deployment in Ontario.

The subsidy was initially set at 1.2 cents per kilowatt-hour (¢/kWh), but was designed to drop to 1.0 ¢/kWh for the period of March 31, 2003 to March 31, 2006, and will fall to 0.8 ¢/kWh for the period March 31, 2006 to March 31, 2007 (when the program is scheduled to expire). Like the PTC, WPPI payments continue for the first ten years of a project's life.<sup>41</sup>

### 3.4 INDIRECT SUBSIDIES

Deductions from taxable income are another popular incentive in North America. Canada's Renewable Conservation Expense (CRCE) and accelerated depreciation through Class 43.1 of the Canadian tax code have both been used to reduce the tax liability of investors in wind turbines installed in Ontario. CRCE allows 100% deduction of first year expenses for non-tangible items such as reports and studies.<sup>42</sup> More valuable are Class 43.1 deductions; one-third of the declining balance of project costs, including equipment.<sup>43</sup> Like WPPI, these are more egalitarian in that the deductions can be passed through to individual investors or limited partners.

### 3.5 RENEWABLE PORTFOLIO STANDARDS

In their simplest form, renewable portfolio standards (RPS) require that a percentage of electricity be supplied by renewable sources. As such, they are a politically-determined quota for the amount of renewables on a system. They are often coupled with a trading system. RPS and tradable certificates are similar to cap and trade mechanisms for air pollution abatement and have been used in several countries as electricity market liberalization swept the globe during the mid-1990s.<sup>44</sup>

In the trading system, each utility receives a credit or certificate for a specified amount of renewables. Utilities that fail to meet the RPS quota are fined. The value of the fines determines the upper value of the tradable certificates.

Owners of the credits can trade among themselves. Some utilities may not add any renewable capacity, instead buying the credits they need from those who do. According to theory, this results in more renewables being installed in areas where the renewables are most suited.

In some jurisdictions, the fines (sometimes euphemistically described as “alternative compliance payments”) enable a utility to pay into a fund in lieu of its renewables obligation. The funds collected are then distributed by some public agency to provide “public goods” or “system benefits” that may not otherwise occur.

Renewable portfolio standards combined with trading have been used with varying degrees of success in Great Britain, Australia, Sweden, and in several U.S. states.

Many proponents of RPS programs emphasize the renewables obligation, or target, and do not specify the mechanism for reaching that target.<sup>45</sup>

### 3.6 TENDERING OR BIDDING SYSTEMS

Often associated with RPS programs are cumbersome tendering systems requiring prospective renewable energy providers to bid against each other for the right to a purchase power agreement or long-term contract. Often the bids are scored most heavily on price, and little value is placed on renewable energy’s other attributes (e.g. regional development, employment creation, increased grid stability).

This focus on price alone is unfortunately the current direction taken by the provincial government in its Request for Proposal (RFP) to build 300 MW of new renewables.

Tendering demands a heavy administrative burden, is time consuming, and costs participants dearly. A key problem of tendering systems is that they reduce the diversity of the participants, and lead to ownership concentration in the wind industry as only the largest enterprises can gain the economies of scale needed to compete on price alone, and risk losing the costs of participating in a bid.

Another serious problem is that tendering systems greatly favour development concentration in the windiest areas, which can have detrimental implications in relation to planning, public opinion and acceptance of projects. From a systems integration point of view, this tendering system also decreases the advantage of having wind developments located over a large geographical spread (which reduces fluctuations in electricity production).<sup>46</sup>

In Britain a tender system known as the Non-Fossil

Fuel Obligation completely failed due to gaming of the system by winners of project bids, lack of penalties for failing to install promised projects, and lack of adequate planning procedures.<sup>47</sup> The dismal failure of this tender system led the British government to abandon the model in favour of a trading system.

In the United States, the PTC is used to lower the bids submitted under RPS programs. However, because the PTC is useful only to those with a significant tax liability, there is no opportunity for small projects, community-owned projects, or farmer-initiated projects to compete with commercial wind developers and non-regulated subsidiaries of the electric utilities themselves. In the United States, nearly half of all new wind capacity installed in the past four years has been developed by the non-regulated subsidiary of Florida Power & Light.

In the U.S., competitive bidding systems and the unpredictable nature of the PTC have not provided a stable domestic market for wind energy as evidenced by the lack of domestic wind turbine manufacturers. Currently, only GE Wind has a manufacturing presence in the United States.<sup>48</sup>

To illustrate the unstable nature of the U.S. market, installed wind capacity declined 30 MW in 1997 from a total of 1,600 MW, nearly all in California. Then 600 MW were installed in 1999, the second great wind boom in the United States. The following year only 70 MW was installed. 2001 was another boom year with 1,700 MW installed, followed by only 400 MW in 2002. In 2003 another wind rush was on to complete projects before the PTC expired, resulting in another 1,700 MW.

No manufacturer can predict with any degree of certainty what the market for wind turbines in the United States will be from one year to the next. As a consequence, few can justify the investment in manufacturing assets when the utilization of those assets is so uncertain.

It is instructive to note that despite the installations in 2001 and 2003 that of the 6,400 MW in wind capacity operating in the United States at the end of 2003, nearly one-fourth had been installed under fixed price contracts written in California during the early 1980s.

The experience with the PTC and competitive bidding systems in North America and the resulting ‘boom and bust’ cycles contrasts sharply with that of Germany and Spain. There a manufacturing base is well-established, a skilled workforce and education networks exist to train wind researchers, developers, and installers, and this is all actively supported by a dynamic and competitive market.

### 3.7 RENEWABLE ENERGY MECHANISM (REM)

Countries leading in the renewable energy sector have followed a different path than certificate trading and tendering, a path not unlike that of California during the early 1980s. These leaders have used Renewable Energy Mechanisms (REMs) instead.

As explained in the introductory chapter, REMs evolved from the original electricity feed-in laws enacted by Denmark and Germany.

REMs facilitate the interconnection of wind turbines with the electric-utility network and at the same time specify how much the wind turbine owners are paid for their electricity.<sup>49</sup>

The REM systems currently in place in Germany and Spain are the single most successful mechanism for stimulating the rapid development of wind turbines.

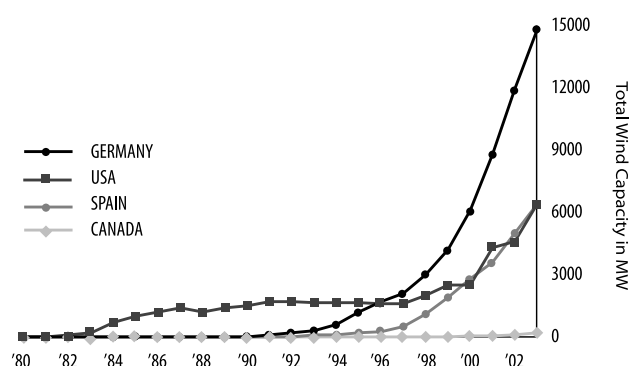

**FIGURE 4** Despite the size of its market and its initial lead in wind development, the United States has fallen far behind the meteoric rise of German wind development. Germany leads the world in wind development as a direct result of its renewable energy mechanisms. Similarly, Spain, which also uses renewable energy mechanisms, now rivals the United States. Canada is still trying to find its way forward.

No other renewable energy support mechanism has produced more renewable energy than the original German feed-in laws and the subsequent introduction of REMs. There were more than 14,000 MW of wind-generating capacity operating in Germany at the end of 2003. This is a fleet capable of producing 18.6 TWh annually, the equivalent of more than 10% of Ontario's current electricity use.

The fixed-price, long-term contracts that result from REM have spawned in Germany and Spain dynamic markets with several wind turbine manufacturers, and a host of suppliers.

During the years that Denmark relied on REMs, the resulting stable markets helped local wind turbine manufacturers to become world leaders in the technology.

Through the mid 1990s, Denmark's 2,100 wind cooperatives accounted for one-half of the nation's total installed wind capacity. Some 100,000 Danish households, or nearly 5% percent of the population, own a stake in a cooperatively-owned wind turbine. Furthermore, farmers own many of the remainder turbines.

As a legacy of its experience with REMs, 20% of all the electricity used in Denmark today is generated using wind turbines.

REMs are more egalitarian than almost any other support mechanism, enabling communities, cooperatives, and farmers, as well as commercial wind power developers, to participate in the rapid expansion of renewable capacity. Renewable mechanisms offer opportunity to many players, and offer farmers a potentially new cash crop – wind-generated electricity. Moreover, REMs create a dynamic market, which is essential to encourage domestic manufacturing.

The fixed-price contracts under REMs also reduce price volatility from utility purchases in the spot market, helping to ensure price stability.

## 4. Conclusions and further research

Ontario has a significant wind resource. What is needed is the political will to implement the technology. Wind energy could deliver as much as one-third of Ontario's present supply. Near term, wind energy could contribute nearly 10% of current supply by 2012 if political commitment toward renewable energy is expressed and new policy mechanisms are put in place quickly to make this happen. The mechanism most likely to succeed in stimulating rapid deployment of wind energy in Ontario is renewable energy mechanisms similar to those used so successfully in Germany.

Issues that additional research may help clarify include: how best large amounts of new renewable capacity can be integrated into the Ontario network, and more detailed mapping of the province's onshore and offshore wind resources and zones of exclusion.

There is little need for additional research into the technology of wind turbines themselves. Wind turbines

are sufficiently advanced and large-scale deployment can begin immediately. However, questions remain about a programmatic wind assessment, which would be valuable for identifying public concerns as well as to identify areas where wind energy is not suited. A programmatic environmental assessment would examine the effects from phased development and from full build-out of Ontario's wind potential. This would obviate today's piecemeal approach that places a burden on wind projects of any size, while offering little overall perspective on wind energy's cumulative effects.<sup>50</sup>

Likewise, there may be other social and technical issues of concern that while studied elsewhere – often at length – Ontario may well want to evaluate under provincial conditions such as: public perception of wind

development, noise propagation, and visual intrusion.

The resource analysis used in this report is based on the experience of wind development in several leading countries, notably Germany.

However, it would be valuable to identify southern Ontario's wind resource on a one-kilometre by one-kilometre grid overlaid with zones of exclusion for roads, villages, parks, wildlife sanctuaries, military bases and over flight zones, and unique natural features. From this a far more accurate picture of Ontario's wind potential can be identified. Although such analysis is beyond the scope of this report it must be emphasized that there is no need to wait for such a study before beginning commitments for large-scale wind deployment to make a significant contribution to Ontario's energy future.

### RIDING THE WIND IN CALGARY

Calgary, Alberta, is home to the first public light rail transit system in North America powered by wind-generated electricity.

The fleet of 116 trains, which run along more than 38 kilometres of track and 36 stations, are all powered by 12 windmills located in southern Alberta. The power generated by the windmills is sent to the main power grid.

By using wind power to run the trains, the city of Calgary reduces carbon dioxide emissions by 26,000 tonnes each year – equivalent to eliminating 7.5 million vehicle trips in Calgary each year.

In 2001, Calgary Transit partnered with ENMAX

and Vision Quest Windelectric to develop a program called "Ride the Wind!" that uses wind-generated electricity to power its C-Trains.

Since its inception in 1981, the C-Train has increasingly become a popular mode of transportation for Calgarians. More than 200,000 people ride the C-Train every weekday – representing a 93 percent increase in ridership since 1995.

The downtown area is a free fare zone in which it is free to ride the LRT, however a fare must be paid if you are traveling outside the downtown area. Rush hour service has a five-minute frequency and off-peak service is reduced to 15-minute service.



## WIND CHAPTER NOTES

- 1 The role of small or household-size wind turbines in Ontario is not discussed here. For information on small and household-size wind turbines and how they are used see Gipe, P. (2004). *Wind Power: Renewable Energy for Home, Farm, and Business*, White River Junction, Vermont: Chelsea Green Publishing. Readers interested in understanding more about wind power are encouraged to examine the “guided tour” of the Danish Wind Industry Association at [www.windpower.org](http://www.windpower.org)
- 2 Gipe, P. (1995). *Wind Energy Comes of Age*. New York: John Wiley & Sons.
- 3 All statistics presented here are derived from numerous sources, including but not limited to national trade associations and BTM-Consult’s Wind Market Updates, published annually, and the author’s own records. Amidst the growing politicization – and commoditization – of statistical information on the wind industry, BTM-Consult’s reports are the reference source for independent data on the development of wind energy worldwide.
- 4 Note that analysts track the industry’s growth using installed power in MW, simply because it is the easiest number to gather as each turbine is nominally rated by the size of the generator it carries. The amount of electricity that a wind turbine produces is directly related to the wind resource and the area swept by the wind turbine’s rotor, and only indirectly by the size of the generator.
- 5 BTM-Consult (2003). *World Market Update*. Available at: [www.btm.dk](http://www.btm.dk)
- 6 Robert Hornung, CANWEA, personal communication
- 7 Bundesverband Windenergie, Arbeitsplatzstatistik der Windenergie-Branche für das Jahr 2003, Osnabrück, Germany, background information, 18.02.2004, cites Deutsches Windenergie Institut (DEWI).
- 8 Sørensen, M. (1997). Learning curve: how are new energy technology costs reduced over time? Report of IEA Workshop: Energy Technology Availability to Mitigate Future Greenhouse Gas Emissions. Paris: International Energy Agency. See also Ackermann, T. Söder, L. (2000). Wind energy technology and current status: a review. *Renewable and Sustainable Energy Reviews*, 4, 315–374.
- 9 See EWEA. (2000). *Proceedings of the EWEA Wind Power for the 21st Century Conference*, Kassel, Germany especially papers from Schleswig AG, a utility with probably the largest penetration of wind energy in the world.
- 10 For example, according to page 48 of Electricity Conservation & Supply Task Force. (2004). *Tough Choices, Addressing Ontario’s Power Needs: Final Report to the Minister*. Available at [www.energy.gov.on.ca/english/pdf/electricity/TaskForceReport.pdf](http://www.energy.gov.on.ca/english/pdf/electricity/TaskForceReport.pdf) “Intermittent generators can be valuable as a source of energy for load displacement, but their inherent unpredictability does not allow them to be used for baseload or peaking purposes.”
- 11 See chapter 17 ‘System Integration’ by E. Bossanyi in Freris, L. (1990). *Wind Energy Conversion Systems*. London: Prentice Hall.
- 12 Smith, D. (1990). Wind energy resource potential and the hourly fit of wind energy to utility loads in Northern California. In *Proceedings of Windpower 90, the Annual Conference of the American Wind Energy Association*. Washington, DC: AWEA,
- 13 Kirby, B., Milligan, M., Makarov, Y. Hawkins, D., Jackson, K. and Shiu, H. (2003). *California Renewables Portfolio Standard Renewable Generation Integration Cost Analysis*. Report prepared for the California Energy Commission and the California Public Utilities Commission. Available at: [http://cwec.ucdavis.edu/rpsintegration/RPS\\_Int\\_Cost\\_PhaseI\\_pubrev1a.pdf](http://cwec.ucdavis.edu/rpsintegration/RPS_Int_Cost_PhaseI_pubrev1a.pdf)
- 14 Giebel, G., Gylling, N. and Czisch, G. (2003). *Effects of Large-Scale Distribution of Wind Energy in and around Europe*. Report Available at: <http://www.iset.uni-kassel.de/abt/w3-w/projekte/Risoe200305.pdf>
- 15 Cold winter air contains as much as 15% more energy than that at a standard temperature of 15° C.
- 16 These are not “full-load hours” as used in Europe to describe productivity, merely the number of hours when the wind turbine is generating electricity and not a measure of how many hours the turbine operates at full rated capacity.
- 17 According to Page 57 of Electricity Conservation & Supply Task Force. (2004) op.cit. note 10: “One option that could be attractive is the banking of power with Quebec or Manitoba, allowing those markets to store water and generate more power when it has higher value.”
- 18 According to Page 50 of Electricity Conservation & Supply Task Force. (2004) op.cit. note 10: The advantages of using wind power include: speed of installation (6 months to a year after permitting is complete), no fuel cost, stable generation cost, and a strong correlation to electricity requirements (installations produce more power in winter and during the day).
- 19 For more information about the additional benefits of wind energy see note 1.
- 20 Using this calculation (described in page 6 of Kammen, D.M., Kapadia, K, and M. Fripp (2004) *Putting Renewables to Work: How Many Jobs Can the Clean Energy Industry Generate?* RAEI Report, University of California, Berkeley. Available at <http://ist-socrates.berkeley.edu/~rael/renewables.jobs.pdf>) The person-years estimate can be divided by the average life of the wind facilities (e.g. 20 years) resulting in 5,000 jobs for 8,000 MW of wind turbines
- 21 Helimax. (2004). *Étude sur L’Évaluation du Potentiel Éolien, de son Prix de Revient et des Retombées Économiques Pouvent en Déouler au Québec, Dossier R-3526-2004*. Montreal: Hélimax. Available at: [http://www.helimax.com/dossier\\_r35262004.pdf](http://www.helimax.com/dossier_r35262004.pdf) For 1,000 MW: 6.7 person-years/\$1 million; 121.5 person-years/TWh for operation. For 4,000 MW: 7.7 person-years/\$1 million;

- 107.9 person-years/TWh. It's not clear from the text why there would be more people employed per dollar invested at 4,000 MW than 1,000.
- 22 Assuming 4,000 MW installed at the rate of 1,000 MW/yr and operating for 25 years, the German employment values would produce about 97,000 person-years, versus the estimate of 78,000 person-years by Helimax (2004) op.cit. note 20.
- 23 Ibid.
- 24 See Gipe, P. (2004) op.cit. note 1.
- 25 While legally permitted to do so, the requirements are so onerous, the process so complex, and the payment for their electricity so meager that it is impractical.
- 26 Farmers bear the risk that the developer may not succeed in winning a bid to supply power to the province, locking up the farmer's land for a period of time. Worse, the developer may "flip" the lease and sell the rights to another firm not party to the original transaction.
- 27 5% value from personal communication with German wind development engineer Henning Holst; 4%, 6%, 8% per succeeding decade from Texas Land Commission, Indian Mesa project, as reported by the Alternative Energy Institute, West Texas A&M University, Canyon, Texas. 3.8% for the first 15 years, 5.4% after from a prospectus for a Bürgerbeteiligung in the German state of Baden-Württemberg. Ontario offers vary from 2% to 2.75%.
- 28 The 1-MW turbine is used here only to illustrate the potential. Many wind turbines today are larger.
- 29 Political risk is not insignificant in Ontario. Pioneering wind turbines installed at great expense under past policies initiatives have been stranded by political changes in the province. Recurrence of that problem will hurt financing of future projects.
- 30 The best example for the necessity for such studies is Buffalo Ridge, Minnesota. In national wind resource studies the area of Buffalo Ridge, a gentle rise in the southwestern corner of the state between the drainages of the Mississippi and Missouri Rivers, was classed as only a modest resource. The state of Minnesota conducted a decade-long wind resource assessment and in so doing discovered a powerful, but overlooked, wind resource. Today there is 550 MW of wind capacity operating in the vicinity of Buffalo Ridge.
- 31 The common practice in the electric utility industry is to represent generating capacity in megawatts (MW). While this nomenclature is useful when comparing similar sources of generation or for the amount of instantaneous capacity needed to meet demand, it is less so when describing potential resources and especially intermittent resources without energy storage, such as run-of-the-river hydroelectric and wind generation. As a result, Ontario's potential wind resource is described in terms of energy in TWh and not MW.
- 32 Ontario Wind Power Task Force. (2001). *Industry Report and Recommendations*. Available at [www.newenergy.org/Wind Power Task Force Report, February 2002.pdf](http://www.newenergy.org/Wind Power Task Force Report, February 2002.pdf).
- 33 The study estimated that the wind resource could be used to generate about 18 TWh of electricity annually (the significantly lower generation estimate is due to the fact that the study used 1991 wind turbines). The study was carried out by R. Lynette and Associates for public hearings on the Ontario Hydro 25-Year Demand/Supply Plan of 1991 and it used a sophisticated approach to estimate the acceptable potential for wind energy in the province.
- 34 This estimate uses data and an analytic approach provided by Jim Salmon, Zephyr North, Burlington, Ontario.
- 35 Note that analysts track the industry's growth using installed power in MW, simply because it is the easiest number to gather as each turbine is nominally rated by the size of the generator it carries. The amount of electricity that a wind turbine produces is directly related to the wind resource and the area swept by the wind turbine's rotor, and only indirectly by the size of the generator.
- 36 Calculation assumes a capacity factor of 20%.
- 37 In arguing the case for nuclear power, the Supply Task Force noted its capital intensive nature and as a result nuclear's need for fixed-price contracts. "Long-term supply contracts provide the best mechanism for ensuring price stability" see Electricity Conservation & Supply Task Force (2004) op.cit. note 10.
- 38 For an exciting account of leaked documents, power politics, and how California became the one-time hotbed of renewable energy development see Roe, D. (1984). *Dynamos and Virgins*. New York: Random House.
- 39 All the companies that opted for this contract went bankrupt within a few years.
- 40 For more details see Gipe (1995) op.cit. note 2.
- 41 Tampier, M. (2004). *Background Document for the Green Power Workshop Series*, Toronto: Pollution Probe and Summerhill Group.
- 42 Ibid.
- 43 Ibid.
- 44 For a discussion of the pros and cons of politically-determined amounts and politically-determined prices see pages 18–23 of Hvelplund, F. (2001). *Political Prices or Political Quantities? A Comparison of Renewable Energy Support Systems*. Osnabrück, Germany: New Energy. Available at <http://www.ontario-sea.org/REMs/EFLFredeHvelplundBerlin2002.pdf>. Hvelplund's book examines this topic in more detail. See Hvelplund, F. (2001). *Renewable Energy Governance Systems: A Comparison of the "Political Price-/Amount Market" Model with the "Political Quota-/Certificate Price Market" System (The German and Danish cases)*. Aalborg University: Institute for development and Planning.
- 45 Wiser, R., Porter, K., Bolinger, M. (2002). *Comparing State Portfolio Standards and System-Benefits Charges Under Restructuring*. Berkeley: Lawrence Berkeley National Laboratory. Wiser has written extensively on Renewable Portfolio Standards and his work, and that of Mark Bolinger are available on the LBNL web site, <http://eetd.lbl.gov/ea/EMS/cases/>

- <sup>46</sup> Kjaer, C. (2004). Support Mechanisms. Brussels: European Wind Energy Association. Available at [www.ewea.org/documents/supportmech.pdf](http://www.ewea.org/documents/supportmech.pdf)
- <sup>47</sup> *ibid.*
- <sup>48</sup> GE Wind also manufactures wind turbines in Germany.
- <sup>49</sup> For detailed information on REM see [www.ontario-sea.org/REMs/REMsList.html](http://www.ontario-sea.org/REMs/REMsList.html)
- <sup>50</sup> Using the federal Wind Power Production Incentive triggers a federal environmental assessment for a project as small as one turbine. Similarly, Ontario's current trigger for a provincial environmental assessment is 2 MW. Many wind turbines today are 2 MW or larger.

# 3

## Hydroelectricity in Ontario

### Summary

**HYDROELECTRIC FACILITIES PROVIDE** A clean and low-cost source of energy that meets more than a quarter of Ontario's electricity requirements.

Ontario's hydroelectric industry currently generates \$1.7 billion in annual energy production and supports 3,600 jobs. Plant operators invest approximately \$250 million in operating and maintenance budgets and contribute \$140 million annually in water royalties to the government.

The past decade has seen a small increase in the number of hydropower development projects in the province, with only 150 MW of new capacity being installed as a direct result of \$400 million in long-term capital investment.

Ontario has over 2,000 potential hydropower sites, of which only 200 have been developed. Ontario has the option of developing and refurbishing an additional 1,000 MW of small-scale and low-impact hydroelectric sites.

Using a conservative estimate for job creation, this additional hydroelectric potential could increase current employment in the hydroelectric sector by about 7% (accounting for an additional 240 jobs in the province).

Although this estimate indicates that the technology has a lower employment creation potential than other renewable options, many new hydroelectric facilities can be located in parts of Ontario currently facing economic hardship and chronic underemployment. Small, low-impact hydroelectric facilities in particular are especially well-suited for community development purposes because they can create employment, increase economic activity and protect local energy security. Renewable energy mechanisms can be tailored to facilitate the development of these facilities.

Ontario's existing hydroelectric facilities have ample potential to also support the 8,000 MW of wind facilities recommended for development by this study. The province's installed dispatchable and storage-based hydroelectric facilities have many times the capacity to support and help integrate the proposed wind development.

Integrating significant wind resources into Ontario's electrical system is not constrained by technological challenges. Although detailed technical assessments need to be conducted, the key obstacles are political and financial in nature. What is needed is cooperation between existing hydroelectric facilities and new wind facilities, and political will to create a financially acceptable operating platform.

### 1. Background on hydropower

The transition from the age of steam to a modern electrical society has deep roots in Ontario. Starting in the late 19<sup>th</sup> century, hydroelectric generation powered Ontario's economic engine and helped develop one of the wealthiest regions in North America.

As technology evolved, cities and towns located near suitable sources of waterpower quickly traded in their water wheels for hydraulic turbines. In 1883, Ottawa was one the first cities in North America to light its streets using renewable energy from the Ottawa River.

With the advent of alternating current and transformer technologies, high-voltage transmission lines were developed. This allowed energy to be transmitted over long distances, a necessity when considering that suitable hydraulic resources are rarely located near urban load areas.

From these early beginnings, Canada has grown to become one of the leading hydropower producers in the



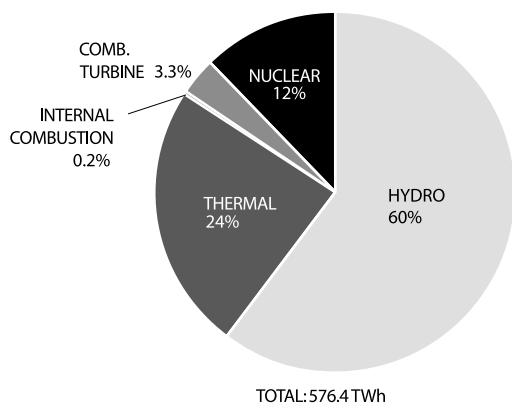

FIGURE 1 Canada's electric power generation (2002)  
Source: Statistics Canada

world. Today, Canada has about 450 hydroelectric plants, representing a total installed capacity of 67,000 MW, which provide 60% of the Canadian electrical supply mix.

At the end of 2003, Canada had an additional 2,400 MW of additional capacity under construction, 600 MW of refurbishment projects, and more than 6,200 MW of hydroelectric development in the planning stages.

Although Canada is a major developer of hydropower, what is not usually specified is how much of this renewable energy technology is low-impact environmental technology.

Large hydroelectric facilities require costly, custom, detailed engineering programs and environmental assessments due to the physical size of the plants and the environmental damage resulting from reservoir flooding, sedimentation, destruction of fish and wildlife habitats and concerns about greenhouse gas emissions.<sup>1</sup>

Small-scale hydroelectric development requires comparatively little physical space while only occasionally causing more local ecosystem damage than natural flooding, drought, and erosion rates present prior to plant commissioning. Many negative environmental impacts can be avoided by good design, involvement of local landowners and appropriate construction and operating practices.

The Canadian Environmental Choice Program offers Ecologo Certification for qualifying renewable, environmentally low-impact electrical generators and can be used as a guide to minimize the environmental damage of a hydroelectric development.<sup>2</sup>

At the end of 2003, there were 224 small hydro plants operating in Canada with a total installed capacity of 996 MW. An additional 53 MW of capacity are now under construction or in the late planning stages.

Ontario's 50 river systems provide the energy to power

8,150 MW of installed hydroelectric capacity.<sup>3</sup> Ontario Power Generation (OPG) owns the vast majority of this capacity, controlling 36 large-scale facilities with an installed capacity of 6,796 MW. In addition, OPG owns a further 29 EcoLogo certified green power sites with a capacity of 125 MW.<sup>4</sup> The remaining 1,229 MW of hydroelectric capacity are provided by Non Utility Generators (NUGs).

According to OPG statistics, low-impact hydro accounted for approximately 95% of its 2002 green power generation, providing approximately 700 gigawatt hours of electricity (sufficient to supply the annual needs of about 60,000 Ontario homes).

## 1.1 WORLDWIDE HYDROPOWER DEVELOPMENT

Hydropower generates about 17% of the world's electricity; however, due to the fact that most countries use different definitions for determining small hydroelectric facilities it is not feasible to provide a definitive estimate of the total world installed capacity of small-scale hydropower.<sup>5</sup>

Nevertheless, country-specific information is readily available and indicates that countries in all continents are stepping up their deployment of small-hydro facilities.<sup>6</sup>

## 1.2 HYDROPOWER IS AN ESTABLISHED BUSINESS

Hydropower accounts for nearly \$1.7 billion in annual energy production in the province. Water leases total more than \$140 million a year, the largest single source of natural resource-based income paid to the province.

Outlining a specific range of capital costs is difficult due to the site-specific nature of projects. Nevertheless, private developers indicate an average range of \$1.5 to \$3.0 million per MW of installed capacity.<sup>7</sup>

Sites that do not require long penstocks or canals, roads or bridges can have a large effect on first-time costs (costs that are not directly related to the capital necessary for power production). Under favourable conditions, systems may be installed for as little as \$1,000 per kW.<sup>8</sup>

In the past decade, the development of 150 MW of hydropower capacity in Ontario resulted from an investment of \$400 million or \$2,670 per kW capacity.<sup>9</sup>

Small projects have similar assessment and engineering issues to large projects, but small developers often have lower overhead costs. Additionally, run-of-river systems do not require large reservoirs or catchment structures, driving first-time costs downward.

From an income statement point of view, small developers appear to stand on equal ground with their large project counterparts. Industry figures indicate that EcoLogo certified sites can generate power with a suitable return on investment in the \$55 to \$65 per MWh range, which is comparable to new large-scale projects.

### 1.3 TECHNICAL CONSIDERATIONS

Well-planned hydro generation sites are designed to use as much of the flowing water as possible, without harming the local ecosystem.

Seasonal variations in water flow may prevent a site from running continuously or at its rated capacity (nameplate rating). The ratio of actual yearly energy production to total potential energy production, given the nameplate rating of a power plant, creates a de-rating coefficient for the station known as the capacity factor. The capacity factor for sites in Ontario varies widely and sites with reservoirs operate at higher capacity factors than run-of-river units.

Established hydroelectric sites with significant reservoir capacity can store water and provide dispatchable energy, which may be utilized to provide electricity during peak use times and also to offset the intermittent nature of other renewable resources (in essence acting as a large battery that can be turned on and off as needed). These latter sites are known as peaking plants, resulting from their inherent flexibility of supply.

Run-of-river hydroelectric sites do not have significant reservoir capacity and therefore have lower capacity factors than sites with reservoir storage. These plants have two key constraints: first, the hydroelectric site must be operated continuously at or near maximum output coincident with available water resources (i.e. as a baseload facility); and second, plant capacity must be overbuilt to compensate for the lack of reservoir. Baseload plants are not dispatchable, operating with lower economic value than dispatchable, peaking facilities, although at a greater value than intermittent supplies.

Capacity sustainability is a concern when peaking hydroelectric generation is operated extensively (for example, as a result of high electricity demand in hot, dry periods or in response to pressure to sell energy during a lucrative spot market). If this operating mode continues over a period of time, storage water levels may prove insufficient to meet generation demand. The province is susceptible to this energy constraint as a quarter of total electricity use depends on hydroelectricity.

Hydroelectricity generation can be divided into four broad categories: micro, mini, small, and large-scale. Micro and mini-scale units are used in individual applications and small communities. Small hydro systems feed baseload (generally non-dispatchable) electricity into the distribution or transmission grid. They are designed to capture the energy of flowing water directly, without the need for water impoundment and large dams. Large hydro requires the construction of large dams and reservoir areas, which store potential energy and provide valuable dispatchability.

There is no international consensus on the definition of small hydropower and many countries use turbine or station capacity as the defining measure.<sup>10</sup>

Small hydro facilities can be connected to either the high-voltage transmission system or a local distribution system. Connecting these smaller renewable generators to the distribution grid does not result in significant impacts to the electricity system.

However, Ontario's interconnection rules to the distribution system are not harmonized, resulting in a mix of confusing rules and regulations throughout the province.

Harmonizing these rules is an essential step to facilitate the implementation of new small hydroelectric facilities. In addition, the development of simplified protection and interconnection norms should also be provincial priorities to enhance the widespread adoption of these systems.

### 1.4 INTEGRATING EXISTING HYDROELECTRIC FACILITIES WITH NEW WIND PLANTS

Wind energy and some other forms of renewable energy are intermittent, to some extent predictable, but nonetheless variable over time. In this regard, wind energy is not unlike run-of-the-river hydroelectric or solar photovoltaic systems where their generation responds to the flow and natural cycle of the resource.

Studies in the United States and Canada have shown that the coordination between wind generation and electric utilities can be beneficial to both. The addition of wind generation to an electric utility can improve the economic performance of the electric utility system when operated in a coordinated manner.<sup>11</sup>

The addition of wind power facilities to regional electricity networks can be facilitated by releasing the storage of hydroelectric reservoirs during peak demand times, which maximizes the value of the hydro resource

that may have otherwise been released earlier to meet average demand.

In essence, the grid operator can use available hydro storage as a ‘battery’ that allows for accumulation of water when there is an excess of wind-generated electricity, and to release this stored water to produce electricity when it is most needed.

A study examining the relatively small network serving Vermont found that it was possible to add a large amount of wind generating capacity because of good regional ties with Hydro Québec and Vermont’s neighbours in the New England Power Pool (NEPool).<sup>12</sup>

Modeling conducted for the study determined that the integrated system could absorb a penetration of 58% wind within Vermont (i.e. 810 MW of wind in Vermont’s 1,400 MW system). The model assumed that the network was operated optimally to absorb as much intermittent wind capacity as possible. The study concluded that the integration of wind energy with hydroelectric generation can improve the management of the hydro reservoirs, increasing the value of wind generation, and the availability of hydroelectric storage.

Further elaboration of the relationship between a high concentration of wind generation in Vermont and its integration with Hydro Québec’s network calculated that operating the two synergistically increased the value of wind energy by more than one-fifth above the price wind energy would command on the NEPool system.<sup>13</sup>

These studies illustrate how to resolve a common misperception that wind-generating capacity requires an equivalent amount of capacity in reserve as a backup. In fact the intermittent nature of wind energy is simply another uncertainty that the pool’s elasticity can handle.

At first glance it often appears that an equivalent amount of fast-response, or on-demand generation must be available to back up intermittent resources, such as when winds are light or variable. This observation has unfortunately become a common and widely-entrenched mistake.

Studies and operating experience from utilities in the U.S. indicate that the amount of reserve capacity required to integrate an incremental 1,000 MW of wind generation can be as little as 100 MW (or 10% of nameplate capacity).<sup>14</sup>

It must be emphasized that this figure has a considerable range. Therefore, the province needs to instruct provincial system operators, wind and hydroelectric researchers, and energy analysts to conduct a detailed study to determine and clarify how large-scale wind

generation can interact with the unique characteristics of Ontario’s hydroelectric system.

Although Ontario needs to develop its own estimate of wind-hydro integration using province-specific planning methods, the aforementioned figure provides indication that large-scale wind integration can be achieved at relatively small cost, especially for hydro systems with flexible reserves and considerable surplus capacity.

Integration of intermittent renewables with dispatchable hydroelectric storage in essence creates a synergistic relationship between the two, for example, by increasing the capacity value of wind resources.

## 1.5 THE EFFECT OF INTERMITTENT GENERATION

Grid operators must constantly balance supply and demand on the system in real-time. They have limited day-to-day control over demand, which is determined by their customers, although there are ways to significantly influence this overtime through support for energy management and demand side management programs. Therefore, system operators have traditionally focused on controlling supply – adding or removing generating capacity as required.

There are special challenges facing electricity system operators who want to balance power from intermittent sources like wind, where they can’t decide how much power will be added, and when, but have to accept what the prevailing winds bring them. Yet these challenges can, and have, been met in jurisdictions with significant wind power integrated into the system. It is worth noting that there are also challenges with nuclear power, which can require days or weeks to be brought on-line.

In order to smooth out the variability of wind and other intermittent supply sources, dispatchable generating plants are required. Hydroelectric generation facilities provide a means of varying their energy output on a moment-by-moment basis, effectively “filling in” the dips from intermittent sources such as wind energy. Excess dispatchable generation must also be present in order to absorb energy, (i.e. by reducing energy production) should wind generation production exceed instantaneous system demand.

The Bonneville Power Administration (BPA) in the U.S. Pacific Northwest, for example, is currently offering a number of services that offer proper management of the above issues by using its hydroelectric dispatchable capacity for wind regulation purposes. BPA uses the

flexibility of the Federal Columbia River Power System to integrate wind energy on behalf of other utilities with an interest in purchasing wind power.<sup>15</sup>

### 1.6 BENEFITS OF NEW HYDROPOWER DEVELOPMENT

The costs and benefits of large hydroelectric projects have been well documented.<sup>16</sup> However, the potential benefits of small-scale hydro are usually less understood.

Hydropower development in many cases involves undeveloped sites on rivers (or existing dams without turbines) that are not necessarily near the load, which implies that grid extensions will be required to transmit the power over some distance. Therefore, this chapter concentrates on the potential of developing a multitude of smaller hydroelectric sites (which require lower voltage transmission lines than large hydroelectric plants) and refurbishment of existing sites.

Large hydroelectric systems require connection to the high-voltage grid, which is extremely expensive.<sup>17</sup> Small hydro systems may be connected to either the low-voltage or medium-voltage distribution system, or may be connected to the high-voltage transmission system located a distance away (that is, the generating station may transmit a medium voltage and be stepped up upon arrival to a sub-station).

Small hydroelectric plants can generate the majority of power needed for consumption at local sites. For example, the Abitibi Consolidated pulp and paper mill in Fort Frances, Ontario has a dozen 2 MW small hydro generators which feed the mill first and the local community secondly without the need for a high-voltage transmission system. The design and placement of the distribution/transmission system is site specific.

Furthermore, large centralized generation facilities concentrate investment in one area. Decentralized generation of the same capacity over many sites distributes investment on a more democratic basis and can lead to employment gains and local development.

### 1.7 EMPLOYMENT

Ontario has approximately 200 operating hydropower facilities, of which half are located south of the French and Mattawa rivers. The northern half of these stations are situated in areas that support forestry and mining operations; key contributors to the economies of northern communities.

The operation and maintenance of these facilities directly employ 1,600 people and provide indirect

support to a further 2,000 people. Ontario's 60 hydropower producers invest approximately \$250 million annually in support of these facilities.

Using a conservative employment estimate, development of 1,000 MW of small-scale and low-impact hydroelectric sites in Ontario could result in an estimated increase of 240 jobs in the province.<sup>18</sup>

In addition to jobs directly related to generation and support, an unknown number of spin-off jobs could be created. These new jobs could be created from combining hybrid renewable/fossil fuel systems for remote communities, developing advanced software and hardware systems to integrate hydro and wind, and other supporting technologies.

### 1.8 LOCAL ECONOMIC DEVELOPMENT

Many new hydroelectric facilities can be located in areas that suffer from under-employment and could be a source for new skilled full-time plant operation and maintenance jobs. In addition, approximately 15 to 20% of project capital is spent in the site development area.



FIGURE 2 Environmentally low-impact hydro sites require careful site planning and deployment. The Appleton, Ontario Ecologo-certified plant owned by Canadian Hydro Developers is a run-of-river, 1,350 kW site comprising 2 propeller and 1 Kaplan turbine. Construction was intended to blend into the surrounding residential area by keeping the powerhouse low to the upstream view, preventing obstruction of the historic mill ruins.

Furthermore, for remote or northern communities, the economic and environmental benefits of new hydropower development can be significant. Approximately 300 Canadian northern and First Nations communities currently rely on decentralized diesel generation, a source of greenhouse gas emissions. Diesel fuel is an expensive commodity that must be shipped over long distances, often covering environmentally-sensitive areas. The risk of spillage due to accident or leakage is

considerable. In areas where sufficient hydraulic resources are available, complete removal of diesel generation is possible. In areas with less favourable resources, hybrid systems that combine the operation of diesel generators and small hydro plants can be used to reduce fuel costs and emissions.

## 2. Ontario's hydroelectric resources: key foundation of provincial power

Ontario is blessed with a large number of lakes and rivers, which at first glance should provide an unlimited amount of hydroelectric generating capacity. However, for a given site to be technically viable, it must have sufficient flow and hydraulic head or vertical drop. During the first half of the 20<sup>th</sup> century, Ontario Hydro developed the majority of these accessible sites, leaving aside those with less than ideal development potential. Nevertheless, our analysis indicates that significant hydroelectric potential exists from refurbishing existing hydroelectric facilities and new sites.

### 2.1 ESTIMATES OF ONTARIO'S TOTAL HYDROELECTRIC RESOURCES

The Canadian Hydropower Association (CHA) estimates that Ontario's total additional hydroelectric potential is more than 5,000 MW.<sup>19</sup>

The Ontario Waterpower Association (OWA) has estimated that Ontario's hydroelectric potential totals from 1,200 to 2,000 MW (from re-development, upgrades, and new development).<sup>20</sup>

Surveys conducted over the past 20 years indicate that Ontario has approximately 2,190 feasible sites for development. Unfortunately, two major site assessments conducted for the Ontario Ministry of Natural Resources (MNR) and the International Energy Agency (IEA), concur on the number of sites, but differ greatly on their capacity. For example, the MNR database indicates a total potential resource of 6,046 MW while the IEA database, which focuses on small hydro (<30MW), provides a total of 2,193 MW.<sup>21</sup>

Given the large number of sites and limited hydrological survey data, estimates are subject to considerable error. For example, consider that the MNR database indicates that Freighters Dam on Ahmic Lake is tabulated with a 750 kW capacity rating but has in reality zero head and flow.

While these compilations may be of limited use for determining actual site capacities, the database does provide prospective developers with geographical coordinates for locating potential development sites.<sup>22</sup>

Pivotal research conducted in 1990 by Ontario Hydro remains today as a unique and crucial source for an overview of the hydroelectric resources available in Ontario.<sup>23</sup> That research placed Ontario's total theoretical hydroelectric potential at 19,900 MW. Deducting existing developed capacity from that theoretical potential would indicate that a maximum of 12,400 MW remains as undeveloped potential.

**TABLE 1**  
Ontario's potential hydro resource

Source	Estimated resource potential (MW)
M.N.R.	6,046
I.E.A.	2,193 (small hydro only)
Ontario Hydro	12,400
CHA	> 5,000
OWA	1,200–2000

Note:  
MNR is Ministry of Natural Resources  
IEA is International Energy Agency  
CHA is Canadian Hydropower Association  
OWA is Ontario Waterpower Association

As Table 1 indicates, there are significant discrepancies between available data sources, which clearly suggests that a new collaborative research effort between the provincial government and the hydroelectric industry is imperative to identify and clarify Ontario's hydroelectric resources. Until such research is conducted, the data presented in this report must be considered as a preliminary and rough attempt to quantify Ontario's hydroelectric resource.

The wide discrepancy between the Ontario Hydro estimate and those of MNR, IEA, and CHA clearly suggest that deductions for several constraints have to be factored into the Ontario Hydro data. A variety of social, economic and environmental considerations influence the viability of potential hydropower deployment in the province. The next sections analyze the impact of these variables in Ontario Hydro's estimate of hydroelectric potential.

### 2.2 TECHNICAL RESOURCES

The potential exists to upgrade existing sites, which includes improved turbine runner and generator technologies. There have been no definitive studies completed on this potential, although the Ontario Waterpower Association (OWA) estimates that there is potential for 1,350 MW of increased capacity.<sup>24</sup>

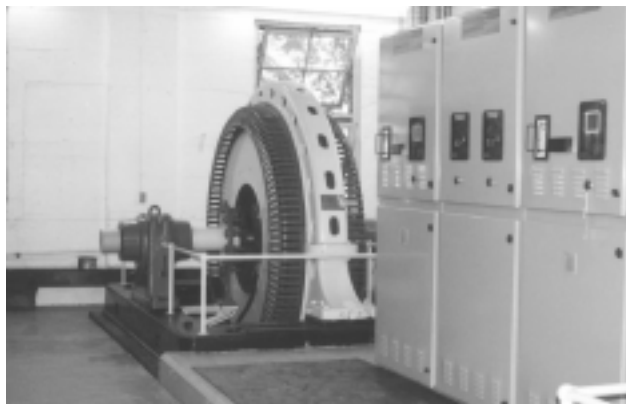

**FIGURE 3** Repair and refurbishment of older hydro generating plants is a viable opportunity for non-utility generators in the province. This plant, constructed in 1906 and located in Galetta, Ontario, was originally developed with 2 x 400 kW synchronous generators. Upgrading the turbines and maximizing water resources has doubled plant capacity from 800 kW to 1,600 kW. (Courtesy of Canadian Hydro Developers and Powerbase Automation Systems Inc.)

Numerous other sites totaling 1,784 MW capacity are excluded from Ontario Hydro's total resource estimation because they lack adequate data regarding soil structure, hydrology, and environmental impact information.

### 2.3 PRACTICAL RESOURCE

Although there is no shortage of sites that could be developed, many of these are in Ontario's far north: the Albany and Attawapiskat Rivers which flow into James Bay, and the Winisk and Severn flowing into Hudson Bay. Complicating matters is the flat terrain of this region, which possesses few rapids or falls of significant magnitude, necessitating large dams which would cause extensive flooding of virgin territory. Furthermore, these dams could result in displacement of First Nations communities and destruction of ecosystems in the watershed areas. Therefore, it is estimated that 5,000 MW of capacity must be discounted from this study for these reasons.

Other site upgrades considered suitable for development include four facilities on the Ottawa River: Chats Falls, Chenaux, Des Joachims and Otto Holden. Such updates would add 796 MW of peaking capacity, while generating only 0.33 TWh of energy per year. Concerns about poor peaking and energy characteristics coupled with fluctuations in water flow on the Ottawa River led us to exclude this capacity from the current resource estimation.

### 2.4 ACCESSIBLE RESOURCE

The creation of 53 new provincial parks in 1988 prevented development of ten large hydropower sites, with a capacity of 694 MW. This constraint is a public policy

issue that could be reversed or modified to allow site development. In the interim, this capacity must be discounted from this study.

An indication of potential change in this area came in early April 2004 when Provincial Natural Resources Minister David Ramsay stated in a press release that the government will open up Crown land so companies can build wind farms and small water-powered electricity plants.<sup>25</sup>

Accessibility plays a factor in the development of remote sites, where economics and infrastructure development, such as roads or grid extensions, are essential considerations. However, there are currently no recorded economic data on accessibility on which to base an assessment. Government and industry as part of the resource assessment recommended above should also undertake a cooperative study reviewing the impact of these issues.

### 2.5 ACCEPTABLE RESOURCE

Allowing for constraints in the Ontario Hydro data results in a resource potential of 4,126 MW, which is comparable to the Canadian Hydropower Association estimate of "greater than 5,000 MW" and the Ministry of Natural Resources study of 6,046 MW. However, of this capacity range only approximately 1,000 MW are available for small, low-impact hydropower development and refurbishments. It must be emphasized that the International Energy Agency resource estimate is based on small hydro sites, and provides a resource level of 2,193 MW. The range of these estimates indicates the need for a more detailed provincial assessment to clarify the potential for low-impact hydropower development.

### 2.6 ONTARIO'S ACHIEVABLE POTENTIAL

One of the few existing sources to estimate the timelines involved in implementing provincial hydroelectric development is Ontario Hydro's 1990 Demand Supply Plan.<sup>26</sup> The Ontario Hydro plan comprised 18 sites, which included nine new sites, three redevelopments and six extensions totaling 2,935 MW of installed capacity. The plan called for development to bring on new capacity in 2000 and complete the program implementation in 2016.

Using Ontario's Hydro's hydroelectric plan as a benchmark and project timeline of what could be achieved in Ontario if significant provincial impetus is placed on hydroelectric development, it is possible to construct a very conservative estimate of what can be achieved between 2004 and 2020.

Under favourable governmental and contractual conditions, it is reasonable to assume that non-utility generators could develop, upgrade or refurbish at least 1,000 MW of existing or new small-hydro capacity over the same study period.

## 2.7 ECONOMIES OF SCALE FOR HYDROPOWER

The dynamics of economies of scale are not nearly as favourable for hydro development projects as compared to other renewable technologies. For example, development of multi-unit wind farms benefit from advantages in economy of scale by amortizing first time design, environmental assessment, engineering and infrastructure costs. Although multi-unit hydroelectric cascade systems may offer some economies of scale, hydropower projects tend to almost always be one-off developments, which do not benefit from the advantages of economies of scale.

## 3. Policies, mechanisms, and incentives to enhance the viability of Ontario's hydroelectric power

A key first step to ensure that hydroelectric development occurs in an environmentally-sound, cost-effective, and sustained manner in Ontario, is that a collaborative study of all provincial hydro development sites be undertaken

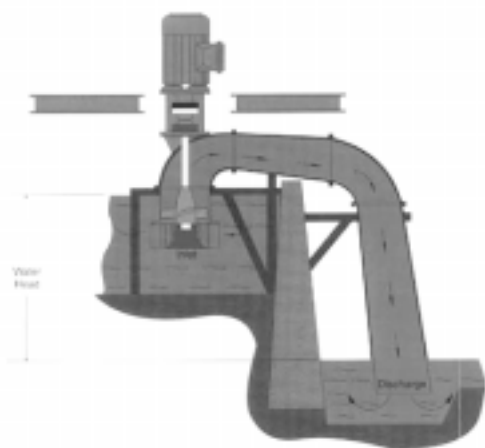

**FIGURE 4** Existing flood and flow control dams dot the provincial countryside without providing any of the benefits of hydroelectric generation. Low-cost, siphon-operated turbines may be installed with a minimum of infrastructure or visual degradation at the site. Units such as the model depicted above are perfectly suited for owner-operated systems located on farms and other rural properties where electrical distribution is within proximity. (Courtesy Mavel Industries)

**TABLE 2**

Estimated contributions – hydroelectric generation

Year	Cumulative capacity in-service (MW) (refurbishment & small hydro)
2004	0
2005	0
2006	0
2007	71
2008	155
2009	260
<b>2010 (mid Kyoto)</b>	<b>435</b>
2011	522
2012	550
2013	580
2014	591
2015	649
2016	798
2017	853
2018	889
2019	946
2020	1,000

Note.

Table 2 does not include the Niagara Tunnel project. The timeline assumes environmental and regulatory assessments completed to allow first projects on line by December 31, 2007.

by government and industry to identify resources using a common methodology suitable to all industry developers. Since accessibility plays a crucial factor in the economic profile of remote sites, elements such as roads and grid extensions need to be considered as part of the analysis.

The proposed assessment should also determine if existing flood control or other non-hydroelectric generating dams already present in the province could be upgraded to allow electrical generation.

Connecting smaller renewable generators to the distribution grid does not result in significant impacts and instead can improve the reliability of the province's electricity system. However, the process regulating connections requires province-wide harmonization and studies regarding simplified protection and inter-connection standards.

Cost and access to the electrical transmission and distribution systems are major potential impediments to all renewable energy technologies including hydroelectric developments. The existing generator-pay approach to new transmission facilities represents a significant barrier that can curtail hydroelectric development. It is recommended that a portion of transmission revenues be applied to upgraded transmission facilities to help renewable energy resources meet supply objectives.

Another key step to ensure that renewable sources are

developed to their full potential is to implement a provincial strategy to ensure that existing facilities with hydroelectric storage can be used to increase the benefits from both wind and hydroelectric generation.

The new Ontario Power Authority should commission the Ontario Energy Board and the new Independent Electricity System Operator to evaluate the integration of varying amounts of intermittent renewables with Ontario's hydroelectric system to determine how best to coordinate operation among these renewable resources.

A critical factor for the successful implementation of new and upgraded low-impact hydro is the establishment of clear directives within all levels of government confirming renewable energy as "core business."

The implementation of a Renewable Energy Bureau, with a mandate to foster clean energy initiatives and practical mechanisms to ensure that these programs are confirmed within all ministries, is essential to ensure that all forms of renewable energy development, including hydropower, are sustained in the province.

Renewable energy mechanisms (REM) are a useful tool that can be tailored by the province to enable local communities, First Nations, cooperatives, and commercial hydroelectric developers to develop hydroelectric projects.

The fixed-price contracts under renewable mechanisms can be specifically designed to stimulate specific types of hydroelectric developments, which may offer multiple benefits for local communities and the province (e.g. low-impact electricity production, employment creation, community economic development, enhanced local

supply security). Furthermore, renewable mechanisms can be designed to ensure that a wide diversity of hydroelectric initiatives are developed, and that the mechanisms act as an incentive to refurbish or develop remote sites.

## 4. Conclusions and further research

Hydroelectric facilities have an historic tradition of powering provincial development, and today continue to provide a low-cost source of electricity that satisfies more than a quarter of Ontario's electricity needs.

The analysis presented here indicates that an additional 1,000 MW of small, low-impact hydro and refurbishments could be available in Ontario (not including the Niagara Tunnel project).<sup>27</sup> These figures are considered preliminary estimates that need to be clarified by a detailed collaborative research study that should be conducted as soon as possible by the province and the hydropower industry.<sup>28</sup>

REMs can be used as a tailored tool to ensure that the most socially and environmentally-desirable hydroelectric projects are developed in Ontario.

Hydroelectricity can play a crucial synergistic role to facilitate the expansion of intermittent renewable resources such as wind in Ontario. Studies and operating experience from utilities in the U.S. indicate that the amount of reserve capacity required to integrate an incremental 1,000 MW of wind generation can be as little as 100 MW (or 10% of renewable nameplate capacity).



### **SMALL HYDRO PROJECT IN QUEBEC A FAMILY AFFAIR**

The Blanche River in Gatineau, Quebec, is a pristine location for canoeing and fishing, as well as generating hydroelectricity.

On the river's edge sits a small hydro station owned by father and son Guy and Stephane Laplante. The station is located on an abandoned Hydro Quebec generating site and has been carefully designed to blend with the surroundings and minimize the impact on the natural environment.

The small hydro generating facility delivers energy (0.5 megawatts) to the Hydro Quebec electrical grid under a 20-year purchase agreement.

A 1981 fire destroyed the previous facility owned by Hydro Quebec. Guy Laplante approached Hydro

Quebec and purchased the site in 1991. The site was commissioned for operation in the winter of 1998. By keeping their capital and operating costs to a minimum, the Laplantes expect an average return on investment of between eight and 10 percent.

A double-wheel Francis turbine receives water from the head intake structure, which is located above and behind the building. Water flows through a buried supply pipe prior to entering the turbine, whereupon it strikes the "runner blade" assembly. Water pressure imparts a torque on the runner blade, causing the drive shaft to turn. The rotating drive shaft in turn causes the generator's rotor to spin, developing electricity for transmission to the electrical grid.



## HYDRO POWERS FIRST NATIONS COMMUNITY

A small hydro station in northern Ontario is doing a lot more than just generating electricity. It's helping local First Nations build a thriving community.

The Pic River First Nation, a small Ojibway community located between Thunder Bay and Sault Ste. Marie, has part ownership in two hydro stations. By selling power from the hydro stations to the Ontario grid, the band has generated more than \$1 million in profits.

Income from the hydro station has helped the band finance a women's crisis centre, a youth centre, a recreation centre, cable television, and high-speed Internet services.

Pic River First Nation first became involved in small hydro development when Chief Roy Michano was invited to sit on a review committee for a proposed hydro development located on Black River, five kilometres east of the community. The Ontario government had identified the site as one with potential for small hydro and was entertaining proposals for development. Rather than take a passive role on the review committee, Chief Michano opted for a more assertive role, choosing to bid for the right to develop the station.



The decision to involve the community in hydro development was based on the band's desire to benefit from this significant economic opportunity. As well, generating power from small-hydro was a good match with the First Nation's view on environmental stewardship.

The Black River generating station opened in 1992. It is a 13.5-megawatt run-of-the-river design, which minimizes the impact on the environment. The power is sold back to Ontario Hydro through a fixed-price, 50-year contract at 6.3 cents per kilowatt-hour.

Experience gained with the Black River hydro development has allowed the First Nations community to gradually build capacity and play an increasing role in the development and management of subsequent hydro ventures. The First Nation has rolled their experience into two other significant run-of-the-river hydro stations.

The Twin Falls Generating Station, a 5.0-megawatt station located on the Kagiano River, and the Umbata Falls Hydro Project, a 23-megawatt station located on the White River are the First Nation's most recent developments.



## HYDROELECTRIC CHAPTER NOTES

- 1 For a detailed overview of the significant problems associated with large-scale hydro developments see [www.irn.org/programs/greenhouse/](http://www.irn.org/programs/greenhouse/)
- 2 For more details see the electricity generation section of [www.environmentalchoice.ca](http://www.environmentalchoice.ca)
- 3 See Ontario Waterpower Association website [www.owa.ca](http://www.owa.ca)
- 4 Ontario Power Generation website see Operations/Hydroelectric Generation [www.opg.com](http://www.opg.com)
- 5 Source of world production of electricity estimate: International Energy Agency [www.iea.org/Textbase/stats/electricityresult.asp](http://www.iea.org/Textbase/stats/electricityresult.asp)
- 6 For country specific information see [www.small-hydro.com](http://www.small-hydro.com)
- 7 Personal telephone interview with Mr. R. Keating, President of Canadian Hydro Developers (May 14, 2004).
- 8 Information derived from Ontario Waterpower Association, “Responsible Industry Facts” [www.owa.ca](http://www.owa.ca) and from surveys of member hydropower developers.
- 9 Ibid.
- 10 For more details see the International Small Hydro Atlas at [www.small-hydro.com](http://www.small-hydro.com)
- 11 Krau, S., Lafrance, G., Saulnier, B., Cohen, J. (2003). *Integrating the Energy Markets in North America: Conditions Helping Large-scale Integration of Wind Power?* In proceedings of 23<sup>rd</sup> Annual North American Conference of AMEE/USAEE/IAEE, Mexico City, Mexico. [http://www.iaee.org/documents/NUIAEEMexico\\_v2.pdf](http://www.iaee.org/documents/NUIAEEMexico_v2.pdf)
- 12 William, C., Saulnier, B. and Cohen, J. (2002). *Assessment of the impact of wind power penetration on the Vermont electricity grid, Technical Reference 1 of 3*. Montreal: Hydro Québec, Institut de Recherche.
- 13 Ibid.
- 14 Hirst, E. (2002). *Integrating Wind Energy with the BPA Power System: Preliminary Study*. Power Portland: Business Line, Bonneville Power Administration. Available at [www.ehirst.com/PDF/BPAWindIntegration.pdf](http://www.ehirst.com/PDF/BPAWindIntegration.pdf)
- 15 For more details see on BPA’s wind integration services see [www.bpa.gov/Power/PGC/Wind/wind.shtml](http://www.bpa.gov/Power/PGC/Wind/wind.shtml)
- 16 For example see the comprehensive report “Dams and Development: A New Framework for Decision Making” authored by the World Commission on Dams available at [www.dams.org](http://www.dams.org)
- 17 Low-voltage systems are by comparison very inexpensive, adding approximately \$50,000 per km compared to an order of magnitude (or more) for a high-voltage transmission line.
- 18 We use a conservative estimate because it is expected that potential employment gains will be limited by the fact that some of the additional capacity will be achieved through upgrading existing facilities. Additionally, new sites have a high level of automation, allowing automatic and remote control from existing monitoring facilities, further reducing new labour requirements.
- 19 See page 52 of Canadian Hydropower association. (2003). Current and planned hydro development in Canada. *Hydropower & Dams*, issue two, 50–52. Available at [www.canhydropower.org/hydro\\_e/p\\_news\\_2.htm](http://www.canhydropower.org/hydro_e/p_news_2.htm)
- 20 See Table 2 in Appendix 2 (New Wind Power and Waterpower Potential) of Boileau, D., Estill, G., Norris, P. (2002). *Generating Investment in Ontario: Final Report of the Renewable Energy Task Team*. Available at [www.canwea.ca/downloads/en/PDFS/Investing\\_in\\_Ontario\\_Final\\_dec\\_11\\_2002.pdf](http://www.canwea.ca/downloads/en/PDFS/Investing_in_Ontario_Final_dec_11_2002.pdf)
- 21 Ministry of Natural Resources Waterpower Site Inventory (Excel Spreadsheet) [www.owa.ca/policy.html](http://www.owa.ca/policy.html) International Energy Agency, Small Hydro Database [www.smallhydro.com](http://www.smallhydro.com)
- 22 See Ministry of Natural Resources Waterpower Site Inventory (Excel Spreadsheet) [www.owa.ca/policy.html](http://www.owa.ca/policy.html)
- 23 Ontario Hydro. (1990). *Providing the Balance of Power: Ontario Hydro’s Plan to Serve Customers’ Electricity Needs: Demand/Supply Plan Report*. Toronto: Ontario Hydro
- 24 See Ontario Waterpower Association website section “Responsible Industry” at [www.owa.ca](http://www.owa.ca)
- 25 See Canadian Press article by Livingston, G. (2004). Ontario must build more electricity capacity to deal with shortfall, IMO says. Available at [www.greatlakesdirectory.org/on/040104\\_great\\_lakes.htm](http://www.greatlakesdirectory.org/on/040104_great_lakes.htm)
- 26 Ontario Hydro op.cit. note 31 see Chapter 12, The Hydraulic Plan.
- 27 According to the Ministry of Energy, the Niagara Tunnel project “will increase the amount of water flowing to existing turbines at the Sir Adam Beck Generating Station to produce an additional 1.6 terawatt-hours of clean, renewable electricity per year – enough power to meet the annual needs of 160,000 homes, or a city twice the size of Niagara Falls.” See Ministry of Energy press release (June 25, 2004): “McGuinty Government Gives Green Light to Expand Electricity Generation at Niagara Falls” available at [www.energy.gov.on.ca/index.cfm?fuseaction=english.news](http://www.energy.gov.on.ca/index.cfm?fuseaction=english.news)
- 28 It is worth noting that research conducted in 2002 by Boileau et al. (2002) concluded that about 1200 to 2000 MW of hydroelectric capacity is available in Ontario from known new development sites, re-developments at existing facilities, upgrades (re-powering and efficiency improvements) and additional new development. See Boileau, D., Estill, G., Norris, P. (2002). *Generating Investment in Ontario: Final Report of the Renewable Energy Task Team*. Available at [www.canwea.ca/downloads/en/PDFS/Investing\\_in\\_Ontario\\_Final\\_dec\\_11\\_2002.pdf](http://www.canwea.ca/downloads/en/PDFS/Investing_in_Ontario_Final_dec_11_2002.pdf) Although the figures quoted on Boileau et al. (2002) are in the same order of magnitude of those provided in this report the key point remains that there is significant variability in all the available estimates of Ontario’s hydroelectric potential. A detailed collaborative study is required to clarify the potential and to provide a timeline and guidelines for implementation.

# 4

## Biomass in Ontario

### Summary

**BIOMASS IS A RENEWABLE SOURCE** of energy that has the potential for significant expansion. Ontario can join a number of progressive industrial nations in Europe that have chosen biomass as a major part of their sustainable energy strategy.

Defined as any organic matter of vegetable or animal origin, biomass provides energy to Ontario today in the form of wood chips, pellets, firewood, and landfill gas. New forms of environmentally-friendly biomass sources are also being developed including high-yielding energy crops, crop residues, and biogas.

While there are some forms of biomass that can have significant negative environmental and health implications stringent standards can ensure a truly sustainable use of this renewable resource.

The biggest advantages of biomass sources are that they can be stored and used when needed, and can be used for a multiplicity of applications including heat, electricity or liquid fuel. Biomass can provide a constant, non-fluctuating supply of energy.

A total energy resource of 288 PJ of biomass can be developed in Ontario.

Between 2010–2020, biomass could supply 53 PJ (or 14.7 TWh) of power generation and 169 PJ for heat applications. This amount of biomass power generation is equivalent to an installed capacity of 2,450 MW. If supportive policies are implemented by 2007 biomass could be supplying 9.1 PJ (2.5 TWh) of electricity, which corresponds with a generating capacity of 426 MW.

Our analysis indicates that Ontario could use biomass for heat related energy applications, displacing the use of heating oil, natural gas, propane and electricity. It is becoming increasingly uneconomical to use high-grade

forms of energy for this application. A total of 160 PJ of new bioenergy resources could be developed in Ontario with 130 PJ of energy from the agricultural sector (mainly from energy crops), 20 PJ of forest sector residue and 10 PJ from the urban waste recovery sector.

Ontario currently uses about 57 PJ of electricity in the residential sector for space and hot water heating. Biomass energy can help displace this load and significantly reduce peak winter loading problems on the electrical grid, and reduce the overall need for power in the province.

As heating oil, natural gas, propane and electricity continue to increase in price; a major biomass heat industry can develop in Ontario without any significant level of subsidies. Research and development support for energy crops and creative financing schemes for the installation of residential stoves and boilers and district heating systems can help this opportunity to be more quickly realized. This is a high priority for developing the biomass sector as it offers a lower cost option than green power incentives. The use of electricity, heating oil and propane in heat-related energy applications could be dramatically reduced in the province. Developing biomass uses will improve Ontario's trade balance, increase employment, support rural development, reduce greenhouse gas emissions, strengthen electricity security, and help in the transition away from coal and nuclear power.

### 1.0 BACKGROUND ON BIOMASS

The term 'biomass' refers to forestry and agricultural products, residues from agriculture (including plant and animal substances), as well as the biodegradable fraction of industrial and municipal waste. Biomass is derived from a large number of products and residues (e.g. straw, sawdust, bark, and manure).

The supply of all biomass types is determined by physical availability, competing uses, and logistical considerations. Biomass conversion systems have been developed to process a variety of biomass types (e.g. combustion of straw, gasification of wood, and anaerobic digestion of manure) and are at different levels of technological maturity. All biomass technologies have their own specific technical and economic characteristics, which are further described in section 2.

The demand for biomass is primarily determined by the demand for heat, electricity, and transport fuels and the costs and convenience associated with competing energy forms that are also meeting this demand. However, environmental and public health considerations and the reliability of the energy supply also play a key role in determining the suitability of biomass sources as replacements for fossil fuels and nuclear energy.

Therefore, the analysis of biomass sources in this chapter also includes discussions on emissions, biodiversity, soil quality, competing uses, and the energy requirements to process biomass into economical and convenient energy forms for consumers.

The forestry sector generates by-products that can be readily converted to energy with presently-available technologies. Most of Ontario's forest sector biomass is a product of the industrial utilization of sawlogs and is already being recovered for energy. However there is some potential for expanded use of bark and sawdust. There is also a need for energy efficiency projects to enable greater energy recovery from the biomass being utilized by the

forest products industry. Some bioenergy advocates are also interested in significantly expanding the use of forest thinnings and recovering more biomass from the forest floor during harvest operations. It should be recognized however that forest productivity is fundamentally dependent on adequate amounts of residual biomass left during harvesting operations to maintain forest nutrient and carbon cycling processes and to prevent soil erosion. Another strategy to expand the impact of forest biomass is to install more efficient combustion appliances in households and commercial buildings. The technology for burning woody biomass (including sawdust, pellets, wood chips and logs) has matured significantly. Consumers can now benefit from technological advances in equipment to provide them with more economical, reliable, convenient and clean burning energy sources from the forest sector.

The resource potential in Ontario for expanding the biomass energy industry from agriculture is large. Growing dedicated energy crops, such as switchgrass and reed canarygrass to produce energy could be a major new industry for Ontario's agricultural sector that could help control rising energy costs in rural areas. Perennial grasses act as solar energy capturing feedstocks, and are more efficient and more environmentally benign than the production of annual grains and oilseeds, which require tillage and moderate to high levels of fossil fuel-based energy inputs. The agricultural sector also generates products such as straw and stalks that could be used for energy purposes. However, these crop residues also play

**TABLE 1**  
Sources of Biomass and their potential energy products

Supply sector	Type	Examples	Energy product <sup>a</sup>
Forestry	Forestry by-products & wood industry	Fuelwood, sawdust, bark, black liquor from pulping operations	H, P, CHP
Agriculture	Lignocellulosic agricultural residues	Straw, stalks, and milling residues from corn and oat processing	H, CHP
	Lignocellulosic energy crops	Switchgrass, reed canarygrass, short rotation forestry	H, CHP
	Livestock manure	Liquid swine and dairy manure	H, P, CHP
	Oilseeds and starch energy crops	Corn, winter wheat, barley, oats, canola and soybeans	H, T
Urban organic wastes	Residues from food industry	Shells, husks, pulp, used frying oil	H, P, CHP, T
	Waste wood	Construction wood, demolition wood	H, P, CHP
	Biodegradable municipal waste	Kitchen and garden waste (KGW), organic municipal waste	H, P, CHP
	Biodegradable landfill waste	Landfill gas	P
	Sewage sludge	Sewage gas	H, P, CHP

Note

<sup>a</sup> H= heat, P=power (electricity), CHP= combined heat & power, T= transport fuel (biodiesel, ethanol)

an important role in maintaining soil fertility and preventing soil erosion on farmlands, and they also have other commercial uses. From a technical point of view of use, biomass derived from agricultural sources has historically proven more complex to use than wood residues, which has delayed development of this sector. Agricultural biomass sources generally have higher ash content, and higher potassium and chlorine contents. These features add difficulty in the combustion process due to the formation of clinkers (i.e. incombustible residues) in boilers, causing complications in their operation, and resulting in increased maintenance requirements. However, a growing number of companies have assessed these inherent quality problems with agricultural biomass and bark, and are now introducing efficient combustion technology into the marketplace for these feedstocks. Several Canadian manufacturers are producing sophisticated new stoves that can effectively burn switchgrass, crop residue and bark pellets as well as corn and cereal grains.

Ontario is also a major livestock producing province and the utilization of manure in Ontario for energy could help other environmental needs. Manure use in biogas systems reduces methane emissions and odours, and helps protect drinking water quality.

Biomass resources can also be recovered from consumers, municipalities and industries that are largely located in urban areas. This includes waste wood leftover from construction and demolition projects, and urban organic wastes that are potentially recoverable from households. The food industry also generates residues from several agricultural products that can be considered for energy use (e.g. waste vegetable oil). Landfill gas systems can also significantly reduce the emission of methane, a harmful greenhouse gas, and enable electricity production.

Greater awareness needs to be developed among Ontario consumers in the area of relative efficiencies of the various bioenergy transformation pathways for converting biomass into useful and economical energy forms that can most effectively displace fossil fuels. In Ontario at present, heat and electricity are the main uses for biomass energy. Biomass can also be used for the production of transport fuels such as ethanol and biodiesel. However, conversion of biomass into liquid fuels for transportation appears limited in Ontario from both an economic and environmental standpoint.

The production of annual grains and oilseeds for conversion into liquid fuels is generally an inefficient way

to utilize farmland to capture soil radiation compared to other energy farming options. Conversion of these commodities into liquid fuels causes significant loss of the original energy from the feedstock. In the case of biomass conversion into ethanol, significant inputs of fossil fuels are required, which results in a modest net energy gain that is finally captured in the corn field. Much more effective fossil fuel substitution can be made when annual grain crops (or oilseeds) are directly combusted to displace heating oil and natural gas. It is increasingly recognized that conversion of annual grains and oilseeds to liquid fuels is the least desirable energy transformation pathway and requires significant subsidization by the taxpayer to create an industry. For example, in using Ontario farmland to produce energy, the net energy gain from a corn field to ethanol fuel cycle (21.4 GJ/ha) represents only a seventh of the net energy gain in the switchgrass field to pellet heat fuel cycle (163.1 GJ/ha).<sup>1</sup> Both the ethanol and pellets are energy carriers that can be used to displace oil on a near equivalent energy substitution basis.

Cellulosic ethanol derived from crop residues has much more potential as an environmentally-friendly energy conversion pathway for bio-fuel production. However, Ontario has higher costs associated with the production of this biomass than Canada's western provinces or tropical countries such as Brazil because of higher land costs. The ease of transport of an energy-dense commodity such as ethanol provides only a limited opportunity for Ontario to have any comparative advantage in developing this industry.

In Ontario, there are greater opportunities to use farmland to produce heat and power from biomass, which is addressed below in more detail.

## 1.1 WORLDWIDE BIOMASS DEVELOPMENT

Two of the leading biomass-consuming countries in the industrialized world are Finland and Sweden. Biomass supplied 19.4% of Finland's total primary energy supply and 7.9% of its fuel mix in district heating. In Sweden, biomass accounted for 15% of total primary energy supply and 53% of the fuel mix in district heating.<sup>2</sup> A key lesson from Finland and Sweden has been the usefulness of strong and stable incentives to develop their biomass markets.<sup>3</sup>

For modern biomass technologies to become a sustainable energy generation strategy, several environmental considerations need to be addressed. For example,

if agricultural and forestry residues are being considered for energy purposes, existing uses of these resources need to be evaluated to avoid compromising ecological cycles. Large monoculture plantations for energy crops should be avoided in favour of planting a variety of species in the landscape as monocultures decrease biodiversity and increase vulnerability to pests and diseases. When considering species selection for energy crops and plantations, it is important to favour moderate to high-yielding plants that require low-inputs of fossil fuel-derived energy inputs and pesticides, as well as low to moderate water requirements. The land base for sustainable bioenergy production from energy grasses and trees should mainly be comprised of marginal lands to ensure that competition with food production is not compromised.<sup>4</sup> As well, there is a need to ensure that clean combustion technologies are introduced into the marketplace. Biomass combustion can be a significant source of air pollution and a health concern in densely populated areas. More communities are looking at controlling the use of fuelwood-burning household appliances to help reduce the particulate load that deteriorates ambient air quality. District heating systems and pellet burning appliances can greatly reduce poor air quality incidents associated with fuelwood burning for heating using wood stoves.

An emerging international strategy that is showing promise is the development of densified biomass for heat and power production. The main advantages of densified fuel pellets, cubes, and briquettes include ease of handling, transport and improved combustion efficiencies due to better control over the combustion process.

Canada is now exporting more than 100,000 tonnes of pellets made from sawdust and other wood processing residues into Northern Europe.<sup>5</sup> The global trade in solid and liquid biofuels will see new trading markets emerge for biofuels and for equipment and technology to develop this new industry. The economics of Ontario's emerging bioenergy industry will undoubtedly be affected in the future by external factors such as the importation of ethanol or foreign-made biomass boilers.

## **2. Biomass is growing as a competitive energy source in Ontario**

The use of biomass is becoming an increasingly attractive heating option, particularly as it can displace expensive

high-grade energy forms like propane, heating oil, electricity or natural gas. As these commodities rise in price, interest in biomass energies will continue to increase. The advancement of technologies is also helping develop the biomass industry as equipment becomes more efficient and convenient to use. The forest products industry has also identified biomass as a strategic opportunity to control their energy costs as fossil fuel prices rise, and to meet their greenhouse gas mitigation requirements under the Kyoto protocol.<sup>6</sup>

### **2.1 TECHNOLOGY CONSIDERATIONS**

There are various technologies to convert biomass into heat, electricity and combined heat and power. Combustion is the most common approach. Biomass combustion systems range, in order of capacity, from domestic heating to district heating and from electricity generation to cogeneration with existing power plants. There are significant opportunities of expanding the use of biomass in residential, commercial and industrial applications.

### **2.2 COMBUSTION APPLICATIONS FOR HEAT**

Biomass has a long history of use for heating Ontario homes. While many rural citizens continue to use locally-available firewood to provide their winter heat, the majority of consumers have switched to more convenient heating systems such as natural gas, oil and electricity. Biomass provides approximately 5.5% of the space heating in Ontario. No significant hot water heating is done by biomass in the residential sector (see Table 2 in Ontario Energy Appendix).

The market is increasingly dominated by natural gas with modest declines in electricity use and significant declines in heating oil in the past 10 years. The residential heat energy industry represents an enormous energy market for biofuel products. Based on 2002 consumption levels and the cost of sourcing fuels from Figure 1, the annual expenditure by consumers on heating (not including capital costs of equipment) are estimated at \$5.55 billion CDN annually in Ontario. The breakdown of the main expenditures is \$3.43 billion on natural gas, \$1.58 billion on electricity, and \$457 million on heating oil.

One important new strategy to increase the convenience and accessibility of biomass heating fuels is densification of biomass material. Biomass is bulky, and both the forest and farm are often quite distant from energy consumers. There are many advantages to densified fuel pellets:

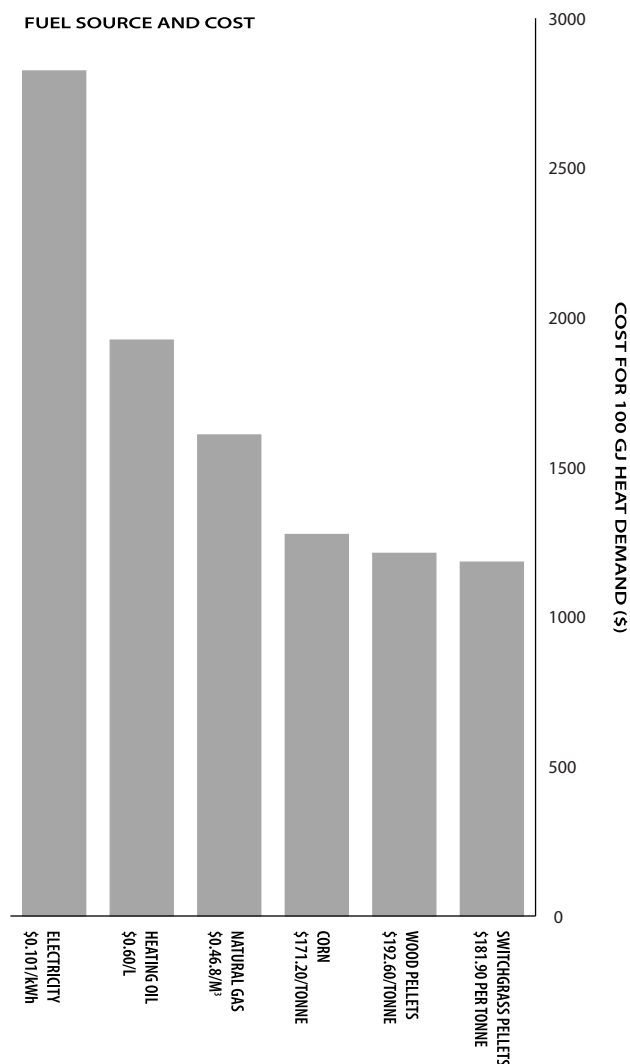

**FIGURE 1** Estimated annual fuel costs for residential heating options in Ontario.

Note:

Assumptions: energy values and conversion efficiencies of electricity 0.0036GJ/ kWh and 100%, heating oil, 0.0387 GJ/l and 82%, natural gas 0.03723 m<sup>3</sup> and 85%, corn 15.8 GJ/tonne and 85%, wood pellets 18.7 GJ/tonne and 85%, switchgrass pellets 18.1 and 85%. Fossil fuel energy prices from Ontario Ministry of Energy ([http://www.energy.gov.on.ca/index.cfm?fuseaction=conservation\\_guide13](http://www.energy.gov.on.ca/index.cfm?fuseaction=conservation_guide13)) and [www.energyshop.com](http://www.energyshop.com). Natural gas also has an annual delivery charge of \$120/yr/household.

- The amount of dust and waste produced is minimized
- The fuel is free-flowing, which facilitates ease of material handling
- The energy density is increased, easing storage and reducing transportation costs
- Uniformity of size and control of flow permits more efficient combustion control

Home heating with “pellet boiler systems” is popular with consumers in Sweden, Austria and Germany. These systems operate like conventional central heating systems and are completely automatic. The boilers are fed wood pellets made mainly of sawdust, shavings, and other

leftovers obtained after processing trees for lumber and other wood products. At a pellet mill, the material is dried, compressed, and formed into pellets. In British Columbia, an association of pellet fuel manufacturers is active in producing pellets for the North American and European markets. An estimated 10,000 Ontario homes now have pellet stoves.<sup>7</sup> Pellet boilers are just beginning to be marketed in the province. The annual savings for switchgrass pellet heating systems vs. electrical, oil, and natural gas heating are 58%, 36%, and 16%, respectively.

Another way of making biomass heating more convenient to energy consumers is through the use of district heating systems, where hundreds of homes can be provided with heat in the form of hot water distributed through underground pipelines. In northern Europe and China, district heating is widely being used to improve convenience for consumers and to save energy and costs compared to the installation of individual boilers for households. There is significant potential for the development of biomass district heating systems and pellet boilers and stoves in Ontario.

The development of 160 PJ of new energy from the biomass sector could have significant impact on the residential sector by helping address Ontario’s power problems. The residential sector consumes about 32% of Ontario’s electricity supply with 55.9 PJ being used for space and hot water heating.<sup>8</sup> Peak winter loading problems are mainly caused by the residential heating sector. With 160 PJ of new biomass energy available in Ontario, the province could halve its use of electricity in space and hot water heating applications in households using biofuels. This savings of 28 PJ of electrical energy could be achieved with 37 PJ (assuming a conversion efficiency of 75% in a district heating system and pellet boilers and stoves) of the 160 PJ biomass resource. In a different scenario, where the status quo of electrical heating in Ontario is maintained at current levels and biopower is used to replace coal in power generation, 93 PJ of biomass would be required to replace the 28 PJ of electricity (assuming a 30% conversion efficiency). Use of biomass for heating in the residential sector to displace electrical heating is a strategic opportunity for the province to encourage.<sup>9</sup>

### 2.3 ELECTRICITY FROM BIOMASS

Generating electricity with solid biomass typically takes place with the help of a steam generation system. Steam



systems are generally too expensive for very small-scale applications, and most district systems are therefore heat-only systems.

Compared to large electricity plants, which have an electric efficiency of 30–40%, combined heat and power systems (CHP) have a low electric efficiency of 20–30%. However, CHP systems can produce both electricity and heat, which results in a total efficiency of 60–90%. An important characteristic of CHP plants is that they have to be located near the consumer of heat, which is often a district heating network or a factory using process heat.<sup>10</sup>

Biomass integrated gasification/combined cycle (BIGCC) systems combine flexible fuel characteristics and high electrical efficiency. Electrical conversion efficiencies of 40–55% are possible at a scale of about 30 MW. Demonstration projects are under way in several countries and for various gasification concepts.<sup>11</sup>

#### **2.4 ANAEROBIC DIGESTION**

Another way to produce gas for power is through anaerobic digestion. This process is the biological degradation of organic material in the absence of oxygen.<sup>12</sup> This process results in the production of biogas, a valuable (energy containing) product. Biogas is a mixture of several gases and vapors, mainly methane and carbon dioxide. Methane also is the main component in natural gas and contains the bulk energy value of biogas. Biogas is a reasonably clean fuel, which can be used in a gas engine or turbine to generate electricity.<sup>13</sup>

Anaerobic digestion of manure for electricity generation is currently applied on a large scale in Germany where about 1,500 farm-scale digesters have been installed.<sup>14</sup> The electricity generated is sold to the grid, and the heat is used for farm and barn heating. The digested manure can then be used as fertilizer on farmland, as with manure that is not digested. Research in Denmark and the Netherlands shows that digested manure has equal or better fertilizing potential than ordinary manure.

Manure digestion for electricity generation is successful in Germany because of the implementation of renewable energy mechanisms targeted for this application, making the country a world leader on this technology.<sup>15</sup>

The same anaerobic digestion process that produces biogas in animal manure and wastewater treatment digesters occurs naturally underground in landfills. Most landfill gas results from the decomposition of cellulose contained in municipal and industrial solid waste. Unlike

animal-controlled anaerobic digestion with manure, the digestion occurring in landfills is an uncontrolled process of biomass decay. The result is that landfills emit methane into the atmosphere (a harmful greenhouse gas with 21 times the heat trapping ability of carbon dioxide). To avoid this problem, the European Union has taken the initiative to make landfill gas capture mandatory (as Ontario also has done for new landfills). In many situations, the collection of landfill gas and its conversion to electricity-using gas engines is profitable, and such systems are becoming more widespread.<sup>16</sup>

#### **2.5 ECONOMICS OF POWER GENERATION FROM BIOMASS**

A recent overview of estimated costs for electricity generation using biomass in Canada concluded that biomass co-combustion (i.e. burning biomass with coal) costs about 7¢ per kWh, landfill gas 6–7¢ per kWh, and biomass combustion 5.5–11¢ per kWh.<sup>17</sup>

However, a more detailed analysis of these costs reveals that landfill gas and co-combustion costs are closer to 4.5¢ and 6¢ per kWh respectively. Other options such as large combined heat and power (CHP) are more expensive and cost about 11¢ per kWh, and farm-based anaerobic digestion systems, which are generally applied at a relatively smaller scale, cost about 17¢ per kWh (for details see Biomass Appendix). Although the costs of anaerobic digestion are currently higher than other biomass technologies, it represents an option that can be relatively easy to implement because of its small scale, the current availability of manure, and the demand for heat at the farm level.

#### **2.6 BENEFITS OF BIOMASS**

If broad environmental considerations and guidelines are implemented, biomass can become a reliable source of heat and electricity generation in Ontario. Biomass can also help cut the province's greenhouse gas emissions as it can displace fossil fuels such as oil and coal. Furthermore, electricity generation from landfill gas is an effective strategy to minimize methane emissions from municipal solid waste. Development of biomass sources can also lead to significant job creation and contribute to rural development.

#### **2.7 EMPLOYMENT**

Employment figures from Germany indicate that more than 50,000 people are employed in the biomass sector

(by comparison about 40,000 are employed in Germany's powerful wind industry).<sup>18</sup>

Recent employment estimates suggest that biomass projects require a range of 10–42 personnel per each 100 GWh/year (i.e. 10 staff if biomass is collected from forestry residues, 36 staff if biomass originates from agricultural wastes, and 42 if biomass is obtained from energy crops).<sup>19</sup> Extrapolation of these employment figures to Ontario indicate that by 2007 between 250 to 1,050 persons could be employed in the biomass power sector, and that by 2020 biomass employment could range from 1,470 to 6,174 jobs (these estimates refer only to potential employment related to biomass electricity generation).<sup>20</sup>

Although these estimates provide only a crude initial estimate of the potential employment benefits, it is clear that the potential economic gains especially for rural areas are quite tremendous. Nevertheless, more detailed, context-specific, analysis is needed to determine the actual employment potential of increasing biomass use in Ontario for electricity and heat applications.

## 2.8 RURAL DEVELOPMENT

Biomass resources can be especially appealing to Ontario's farmers, who are currently facing significant economic hardship. Recent estimates by Agriculture and Agri-Food Canada indicate drastic decreases in Ontario's farm income due to the compounding detrimental effects stemming from loss of U.S. markets and the increase in value of the Canadian dollar.<sup>21</sup>

If environmental safeguards are implemented to ensure that biomass sources are developed and employed in a sustainable way, an expansion of biomass use for energy purposes holds significant potential to provide improved and more stable income levels for farmers and to strengthen local communities. For example, it appears higher farm income receipts could be derived from perennial grasses such as switchgrass than producing beef cattle on marginal farmlands.

As well, manure can be efficiently collected on farms to generate heat and electricity. This strategy can also help minimize the pollution of local water bodies by generating a valuable fertilizer that poses much less risk to human health than liquid manure applications to farmland. Water pollution from untreated manure remains a serious challenge affecting many communities in rural Ontario, a problem that has gained increased attention after the Walkerton tragedy.<sup>22</sup>

## 3. Ontario's biomass resource: A growing diversity of supply

Ontario has a variety of potential biomass resources available from forestry, agricultural, industrial food residues, and waste sources. The next section evaluates the potential of the three main biomass resource sectors in Ontario.

For each type of biomass the total, technical and practical resources available are estimated using the following definitions:

- The total resource is the energy content of the total quantity of biomass that is potentially available, not taking into account environmental, technical and logistical considerations.
- The technical resource is the total resource potentially available, limited by the current technical ability to extract energy from these sources. It is related to the quantity of biomass that could be obtained in an environmentally- sustainable way with help of state-of-the-art technologies. Within a timeframe of 10–20 years it should be possible to develop the resource.
- The practical resource is the technical resource, additionally limited by basic practical incompatibilities such as competing uses of the resource.

### 3.1 FOREST SECTOR BIOMASS

In Ontario, an area of 58 million hectares (ha) is covered with forests, of which 42.2 million ha (73%) is timber productive (class II) forest and 15.8 million ha (27%) is timber non-productive forest.<sup>23</sup> The average biomass density of productive class II forest in Ontario is 87 tonnes/ha. Therefore, in total, about 3.7 billion tonnes of wood biomass is stocked in productive class II forests.<sup>24</sup>

The timber non-productive forests of Ontario consist of open muskeg, treed muskeg, rock, protection forest and brush and alder with varying biomass densities. Using the average stand density of the Boreal shield of 6 tonnes/ha, the total biomass contained in unproductive forest is 95 million tonnes, which is approximately 25% of the biomass stocked in timber productive forests. Moreover, these forests are often reserved and protected from harvesting, as they are extremely slow to regenerate.

### 3.2 TECHNICAL RESOURCE ESTIMATION

Only a small portion of the total stock of wood biomass is available for use on an annual basis as energy. Some

areas are economically unfeasible to harvest and some areas are protected for ecological purposes. The merchantable volume of roundwood harvested on provincial and private lands in Ontario in 2001 is summarized in Table 2.

**TABLE 2**

Net merchantable volume of roundwood harvested on provincial and private lands in Ontario 1999–2002<sup>25</sup>

Year	Volume (1000 m <sup>3</sup> )	Mass <sup>a</sup> (ktonnes)	Energy content <sup>b</sup> (PJ)
1998	24,126	10,133	182
1999	24,814	10,422	188
2000	28,118	11,810	213
2001	29,099	12,222	220
2002	26,319	11,054	199
<b>5-year average</b>	<b>26,495</b>	<b>11,128</b>	<b>200</b>

Note

a Assuming an average solid dry density of 420 kg/m<sup>3</sup>

b Assuming a net calorific value of 18 GJ/tonne

Roundwood is defined as sections of tree stem, with or without bark. It includes logs, bolts, pulpwood, posts, pilings, and other products in the subcategory known as industrial roundwood. It also includes fuelwood and firewood, which are harvested in fairly modest volumes. However, the total quantity of harvested biomass is actually higher, as branches, foliage and (part of the) bark are not included in the statistics. The proportion of total biomass to roundwood differs per type of tree and can vary regionally.<sup>26</sup> In this study however, an approximate estimation is made based on the numbers in Figure 2.

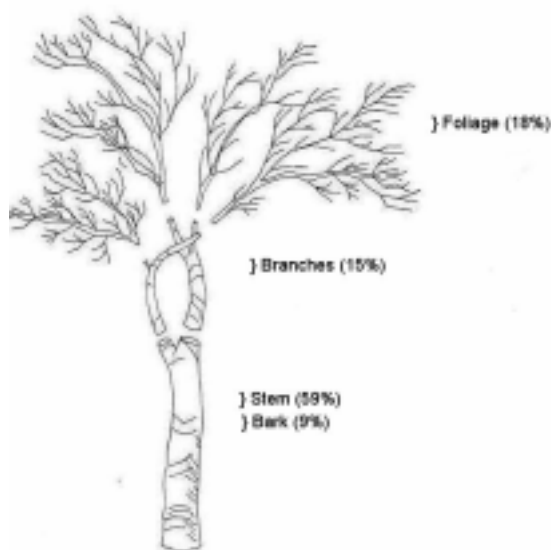

**FIGURE 2** Approximate distribution of above stump biomass (% on dry basis)<sup>27</sup>

In sustainably-managed forests, branches and foliage are left in the forest for maintaining the carbon and nutrient cycling process and to provide habitat for the animals in the forest. Clear guidelines for sustainable forestry have been established by the Forest Stewardship Council, which also provides a certification system to ensure that forests are well managed.<sup>28</sup>

Bark is usually removed centrally, and except for local energy generation it is hardly used for other purposes. Most modern wood processing industries use some the energy contained in bark, for on-site energy generation. Special bark combustion systems are developed for this purpose. The technical potential of this resource if it was used exclusively for energy in Ontario is 229 PJ, consisting of roundwood (200 PJ, Table 2) and bark (29 PJ, Table 3).

### 3.3 PRACTICAL RESOURCE ESTIMATION

While the technical resource estimation is based on statistics about the supply of wood, the practical resource consists of residual products from the paper and pulp industry, the timber industry and wood used in households. Stem wood is generally judged to be too expensive for energy purposes because of competition with the higher-value fibre products industries.

#### BARK

At the time of harvest, most of the bark is removed together with the harvested stem. All 29 PJ (Table 3) of bark can be regarded as the practical resource. Bark is considered the main new incremental biomass resource from the forest sector that can be developed in Ontario. Some of the bark resource, however, is already utilized internally for energy in the forest products industry.

#### BLACK LIQUOR AND WASTE WOOD USE IN THE PULP AND PAPER INDUSTRY

Black liquor refers to the residual aqueous mixture of lignin, organic chemicals and inorganic chemicals recovered after pulping of wood through the Kraft pulping process. In the case of softwood trees, 27–28 % is lignin. The dry solid content of black liquor depends on the evaporator system in the mill, but is typically within the range of 65% to 75%. Its gross and net calorific values are 14.3 and 12.4 GJ/tonne, respectively. In traditional Kraft pulp mills, the black liquor is burned in a chemical recovering boiler, enabling recovery of the inorganic pulping chemicals and conversion of the organic components into thermal energy in the form of

steam.<sup>29</sup> From the viewpoint of sustainability, it is essential to utilize the generated thermal energy in an efficient manner. Natural Resources Canada (NRCan) indicates that the paper and pulp industry uses 83 PJ of energy per year from wood waste and pulping liquor, providing more than 50% of the energy demand in this sector.<sup>30</sup> However, the share between wood waste and pulping liquor is not currently available in NRCan's online database.

#### SAWDUST AVAILABILITY FROM THE SOLID WOOD PRODUCTS INDUSTRY

The lumber, panel and veneer manufacturing industries consume the logs and bolts mentioned in Table 3. It is estimated that in the Ontario sawmill industry, 1.53 million tonnes of wood residues are produced, of which 1.08 million tonnes are already used, and 0.45 million tonnes are still unused.<sup>31</sup> Assuming that these residues consist of 50% bark and 50% sawdust, then it is estimated that 0.76 million tonnes of sawdust are produced. This corresponds with a practical resource of 13.7 PJ of sawdust, of which 70% is used and 30% is projected to be unused. The sawdust that is currently utilized is for heat generation applications and is burnt directly or manufactured into wood pellets for commercial sale in Ontario. There are also significant volumes of wood residues used in the wood processing industry. Shavings are also widely used as bedding in the livestock and poultry industry. The used and unused sawdust are considered part of the practical resource.

#### WOOD FUEL FOR RESIDENTIAL USE

NRCan indicates that in 2001 in Ontario, 16.7 PJ of wood was used in the residential sector.<sup>32</sup> Most of this fuel is cut in forests but some is also slabwood from the forest products industry. It should be regarded as part of the practical resource. There could be some potential for increased use of wood fuel from forest thinnings in the future if energy prices and wood prices rise to help support the high labour cost of this activity.

#### TOTAL FROM THE FOREST SECTOR

The total practical energy potential from the forestry sector is identified as 142 PJ annually (see Table 3). It is estimated that 20 PJ of this is new incremental energy from the forest sector that is not currently developed, mainly consisting of bark.

### 3.4 AGRICULTURE

The agriculture industry offers major potential for expansion of the bioenergy industry in Ontario. Unlike

the forest industry, only limited amounts of biomass have to date been developed. Four types of biomass can be produced from agriculture: grains and oilseeds, energy crops, agricultural residues, and livestock manure. This section will discuss these various biomass options and the overall opportunity to best collect and store solar radiation using crops on Ontario farmland.

**TABLE 3**

Practical resource from the forestry sector <sup>33</sup>	
Resource	PJ
Bark	29
Spent liquor and wood waste	83
Sawdust	13.7
Wood fuels for residential use	16.7
<b>Total</b>	<b>142</b>

The use of annual grains and oilseeds for energy has been widely encouraged by commodity groups in Canada as a means to strengthen demand for these commodities and improve prices. In terms of a system to capture and store solar radiation with energy crop farming, Figure 3 compares the relative efficiencies of present-day Ontario field crops with a bioenergy crop planted for energy. The net energy gain is determined by comparing the total energy production (yield x energy content) and subtracting the energy inputs required for crop production. From Figure 3 it can be seen that there is a fundamental advantage to the use of perennial grasses like switchgrass as energy crops. When densified through pressing and used in modern biofuel combustion appliances, switchgrass pellets can be used as the same energy end-use efficiencies as modern heating oil and natural gas heating appliances. From a fossil fuel displacement and greenhouse gas mitigation standpoint, perennial energy crops represent Ontario's best land-use strategy for developing a major biofuel industry.

#### ENERGY CROP FARMING

There are 3.6 million ha of Ontario farmland managed for crops and forage production (Table 4). Approximately one-third of Ontario's farmland is in forage crop production for the ruminant livestock industry. It may be economically advantageous for several reasons for Ontario farmers currently involved in the ruminant livestock industry to diversify a significant portion of their forage lands into the production of perennial grasses (such as switchgrass or reed canary grass) for energy production. It would let Ontario farmers take advantage

of the increasing value of biomass in the province. Biomass in Ontario is increasingly scarce as greenhouse operators and other large heat energy users switch away from natural gas and other heating systems. Consumers in Ontario face higher energy costs for natural gas and electricity than provinces in Western Canada and

consequently can pay higher prices for biomass fuels. While densified biomass can be transported by rail, it is likely that local production of biomass in Ontario can compete with the costs of importing densified fuels into the province from Western Canada.

With Ontario having 620,000 ha available for biofuel production and assuming a 9 tonne per hectare yield, a total of 5.58 million tonnes of biomass could be grown annually in the province. Assuming this biomass contains 18.5 GJ/tonne, a total of 103 PJ of energy could be produced. This would be approximately six times the energy production potential of crop residues in the province. This energy production base would result from the conversion of approximately 1/6 of Ontario's total farmland into energy crops. The land base would consist mainly of land currently dedicated to the beef industry and to land under cultivation of grain crops, such as oats and barley, in marginal areas that are bringing relatively low profitability to Ontario farmers. Switchgrass and reed canarygrass would be the main initial scale-up species for southern and northern Ontario respectively. Research in Quebec and in South Dakota has also identified prairie cordgrass as a promising warm season grass bioenergy crop that has higher yield potential than switchgrass and is also better adapted to poorly drained soils and areas with cooler nighttime temperatures.<sup>34</sup> The main advantage of using warm season or C4 grasses is that they convert solar radiation 40% more efficiently than cool season species and they use only half as much water for every tonne of biomass produced. Other potential perennial energy crop species in Ontario include the warm season perennial grass species of big bluestem, indiagrass and miscanthus, and short rotation forestry and windbreak species including willow, poplar, black locust, alder and indigo bush.

It will take time to establish a supporting infrastructure and to develop experience in energy crop production amongst farmers. As a rough estimate, it is

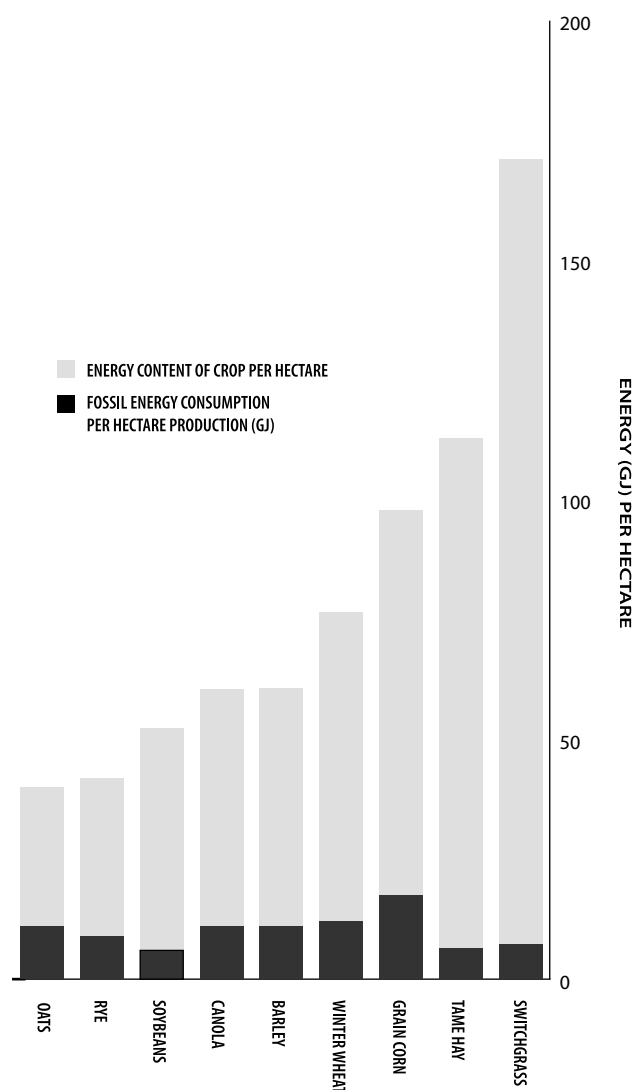

FIGURE 3 Solar Energy collection and fossil fuel energy requirements of Ontario crops, in giga-joules (GJ) per hectare (for sources see Biomass Appendix)

TABLE 4

Potential land base available in Ontario for biofuel production from grasses

Location	Land use categories	Total acreage (millions ha)	Percentage converted to biofuels	Estimated biofuel acreage (millions ha)
Ontario	Annual crops	2.35	10%	0.23
	Hay	0.93	30%	0.28
	Seeded pasture	0.35	30%	0.11
			<b>Total</b>	<b>0.62</b>

assumed that 20% of the required land resource base could be planted within four years, which corresponds to 120,000 ha and 20 PJ of primary energy. After 10 years, the total practical resource of 103 PJ could be achieved. After 2015 there would be an annual expansion of 1–1.5% in the resource base with the ongoing introduction of improved energy crop cultivars and production technologies.

#### AGRICULTURAL RESIDUES

Cereal straws and corn stover are the major potential biomass residues as sources for energy generation.<sup>35</sup> The theoretical, technical and practical resources from agricultural residues in Ontario were calculated using a study on available residues on the basis of crop statistics and crop-to-residue ratios.<sup>36</sup>

Not included in this analysis is the potential for crop residue generated from commodity milling. In Ontario, oat hulls and fibres from corn milling can also be considered a small but important additional crop energy resource for utilization, as they are already concentrated and available at an affordable price.

**TABLE 5**

Energy potential of selected field crop residues in Ontario (PJ/year)<sup>a</sup>

	Total resource (PJ)	Technical resource (PJ)	Practical resource (PJ)
Winter wheat	21	14	5
Spring wheat	3	2	1
Oats	1	1	0
Barley	8	6	2
Rye	1	1	0
Mixed grains	5	4	1
Grain corn	73	36	7
<b>Total</b>	<b>113</b>	<b>64</b>	<b>17</b>

Note

<sup>a</sup> Based on Table 6 and an average lower heating value of 18 GJ/tonne.

The total resource (113 PJ) shows the energy content of all straw that is produced yearly from the relevant agricultural field crops in Ontario (Table 5). It is important to note that a part of these residues must be left on the field to maintain soil quality. Sustainable removal rates depend on many factors, including soil type, slope of the land, soil fertility levels, crop rotation systems, tillage, cutting height, crop yield, weather and wind patterns. Using a removal rate of 60–75% for winter wheat and 70–75% for other cereals, it is estimated that

64 PJ of energy is available.<sup>37</sup> The practical resource (948,000 tonnes or 17 PJ) is estimated by taking into account the alternative uses of the residues (e.g. animal fodder, straw for livestock bedding, mushroom production etc.), and the difficulty in harvesting corn stalks. In addition, the agricultural sector can provide significant amounts of energy from spoiled, mouldy and low quality grains, and from by-products of grain milling (especially corn and oat milling). It is estimated that 275,000 tonnes of grains and grain milling residues, which is 5% of the 5.5 million tonnes of grains produced in Ontario, could be available for bioenergy applications. Assuming this biomass has an average energy content of 18 GJ/tonne, it would provide an additional 5.0 PJ of energy annually to Ontario.

#### LIVESTOCK MANURE

The yearly quantity of manure available in Ontario is estimated by using data on animal stock and manure production per animal. Table 7 shows the resulting energy potentials that were estimated on the basis of calculations on manure availability in Ontario as provided in Table 8. The use of liquid manure sources as energy is desirable from an environmental standpoint as this is the major source of methane and odour emissions from Ontario agriculture and a risk to water quality.

The total resource of 45.1 PJ is equivalent to the energy content of the manure (Table 8). Wet manure of pigs and cows is suitable for anaerobic digestion.<sup>38</sup> The technical resource of 18.7 PJ represents the energy that can be gained with anaerobic digestion. Because biodigestion of chicken and turkey manure is more complex, these resources are not considered as part of the practical potential. Poultry litter, commonly containing wood shavings, can be converted to energy through direct combustion for heat. However this energy conversion pathway is not considered viable for Ontario because from an environmental standpoint, combustion of nutrient rich poultry manure in Ontario should be avoided. Combustion of this material can be a significant source of NO<sub>x</sub> pollution as it generally contains more than 3% nitrogen. This manure is also a relatively rich source of nitrogen and nutrients and can be used as an organic source of nitrogen (N) to displace the use of inorganic N fertilizer forms (such as urea or anhydrous ammonia) in crop production. Most regions in Ontario have a significant cash crop farming land base available for recycling of manure from neighbouring poultry farms.

The availability factor in Table 7 shows how much ma-

**TABLE 6**

Calculation of the availability of agricultural residue in Ontario in 2001

	Area <sup>a</sup> (x1000 ha)	Product yield <sup>b</sup> (tonnes/ha)	Residue to crop ratio <sup>c</sup> (for theoretical potential)	Total resource <sup>d</sup> (ktonnes)	Share of theoretical potential available for technical resource	Technical <sup>e</sup> resource (ktonnes)	Share of technical resource practical available for potential	Practical resource <sup>f</sup> (ktonnes)
Winter wheat	218.5	4.1	1.3	1165	0.68	792	0.35	277
Spring wheat	46.5	2.9	1.3	175	0.72	126	0.35	44
Oats	28.3	2.1	1.3	77	0.72	56	0.35	19
Barley	109.3	3.2	1.3	455	0.72	327	0.35	115
Rye	24.3	2.2	1.3	69	0.72	50	0.35	18
Mixed grains	68.8	3.1	1.3	277	0.72	200	0.35	70
Buckwheat	1.6	1.7	1.3	4	0.72	3	0.35	1
Grain corn	777	5.2	1	4040	0.5	2020	0.2	404
<b>Total (ktonnes)</b>				<b>6263</b>		<b>3574</b>		<b>948</b>

Note

a Derived from various information sources stated in Helwig et al. (2002), Agricultural biomass residue inventories and conversion systems for energy production in eastern Canada, 2002, Resource Efficient Agricultural Production (REAP): Ste. Anne de Bellevue, Quebec.

b Data related to 2001.

c Average yield 1997-2001.

d The total resource equal to the total quantity of residues that is released.

e The technical resource takes into account ecological sustainability; for instance a quarter of the cereal straw has to be left on the field.

f In order to estimate the practical resource, the share of straw that is needed for animal fodder and other purposes is deducted from the technical resource.

nure is released centrally that can be collected and used in an efficient way. The resulting practical resource is 4.9 PJ.

### 3.5 WASTE BIOMASS RESOURCES FROM URBAN AREAS

There are five major types of biomass in the waste sector that are predominantly from urban areas and which can be utilized for energy: waste wood, food residues, biodegradable municipal residues, landfill gas and sewage. These will be discussed in the section below.

#### FOOD INDUSTRY

In the food industry, considerable quantities of organic materials are produced from a great variety of processes. In the agri-food industry, many vegetable residues are currently valued as animal fodder. Slaughterhouse waste is another potential source of energy. However, public perception is generally negative towards the utilization of such residues. Used frying oil is a vegetable product, which is less problematic from the view of public perception. It forms a source of energy that can be utilized for heat and electricity generation or processed further into biodiesel (methylesters). A recent study estimated that in Ontario, 70 million litres of yellow grease is produced corresponding to an energy potential of 2.3 PJ (Table 9).<sup>39</sup>

Identifying all relevant residues is beyond the scope of the present study; however, it is anticipated that the theoretical and practical resources may exceed 50 and

**TABLE 7**

Energy potential of livestock manure in Ontario (PJ/year)

Manure	Total resource <sup>a</sup> (PJ/year)	Technical resource <sup>b</sup> (PJ/year)	Availability factor <sup>c</sup>	Practical resource (PJ/year)
Pigs	11.9	5.9	50%	3.0
Dairy cows	14.3	5.5	12.5%	0.7
Beef cows	5.9	2.3	25%	0.6
Calves, steers and heifers	6.6	2.5	25%	0.6
Chicken (Layer)	2.3	0.9	0%	0.0
Chicken (Broiler)	2.8	1.1	0%	0.0
Turkeys	1.4	0.5	0%	0.0
<b>Total</b>	<b>45.1</b>	<b>18.7</b>		<b>4.9</b>

Note

a The total resource shows the energy that is contained in the manure, assuming a higher heating value of 14 GJ/tonne, and an ash content of 30%.

b The technical resource shows the energy that can be extracted from the manure, making use of the assumed conversion routes as indicated in the last column. It is calculated that pig manure digestion results in 6.98 GJ/tonne dry manure, cattle digestion in 5.34 GJ/tonne. For the others also 5.34 GJ/tonne were assumed.

c It is assumed that only manure that is released in stables can be collected for energy use. The shown availability factors are first estimates based upon existing experience with manure digestion. It would require detailed research beyond the scope of this study to verify these factors.

10 PJ, respectively. The practical resource is currently estimated by the used frying oil, which has an energy value of 2.3 PJ.

#### WASTE WOOD

Waste wood consists of construction and demolition wood and forms a popular feedstock for biomass power plants. Emission controls are very important because

**TABLE 8**

Calculation of the production of animal manure in Ontario in 2001

Manure	Number of animals in Ontario <sup>a</sup>	Average body mass of one animal <sup>b</sup>	Total animal body weight (1000 kg)	Total solids / 1000 kg animal mass per day <sup>b</sup>	Total solid manure/year (tonnes /year)	Total energy potential (combustion) (PJ/year)
Pigs	3,457,346	61	210,898	11	846,756	11.9
Dairy cows	363,544	640	232,668	12	1,019,087	14.3
Beef cows	376,020	360	135,367	8.5	419,977	5.9
Calves, steers and heifers	1,376,732	91	125,283	10	468,714	6.6
Chicken (Layer)	15,693,374	1.8	28,248	16	164,969	2.3
Chicken (Broiler)	27,931,322	0.9	25,138	22	201,860	2.8
Turkeys	3,402,697	6.8	23,138	12	101,346	1.4
<b>Total</b>					<b>3,222,707</b>	<b>45.1</b>

Note

a Source: STATCAN 2004, the data refers to 2001.

b Source: ASAE, ASAE D384.1 DEC99 *Manure production and characteristics*. American Society of Agricultural Engineers: St. Joseph (USA), 2000.

some of this recovered material can be impregnated with preservatives or polluted with paint. The total annual quantity of construction and demolition sources available in Ontario is about 842 kt.<sup>40</sup> It is assumed that about 40 percent of this quantity consists of demolition wood, equaling 337 kt, which is equivalent to 4.7 PJ of energy. It should be possible to collect at least 80 percent of this quantity, forming a technical resource of 3.8 PJ, which can also be regarded as the practical resource.

#### BIODEGRADABLE MUNICIPAL SOLID WASTE

The organic fraction of municipal solid waste (MSW) can be regarded as a source of renewable energy and it is referred to as biodegradable municipal waste (BMW). In Ontario, 6.6 million tonnes of MSW were released in 2000 from residential, industrial, commercial, and institutional sources, of which an estimated 50% can be regarded as BMW.<sup>41</sup> With an estimated energy value of 11 GJ/tonne the total resource of the 3.3 million tonnes is 36.3 PJ/year, which is considered as the total resource. The environmental concerns regarding incineration are numerous; therefore, incineration is not considered in the technical and practical resources analyzed here. The introduction of incineration would also displace some of the energy generation estimates from landfill gas as both energy recovery systems are relying on the same organic waste component as the energy source.

#### LANDFILL GAS

All landfills produce gas as waste decomposes, which is generated during a 30–50 year period, and continues after the closure of the landfill. Landfill gas consists of approximately 50% methane and 50% carbon dioxide,

which are both greenhouse gases. One tonne of methane is equivalent to 21 tonnes of carbon dioxide in terms of global warming potential. Landfill sites generate over a quarter of the methane emissions caused by human activity in Canada, sending 1,200 kilotonnes (kt) of this potent greenhouse gas into the atmosphere each year.<sup>42</sup> In 1999, 290 kilotonnes of methane were collected and either flared or used to produce energy in Canada thereby preventing the release of methane to the atmosphere.<sup>43</sup> Extrapolating this data to Ontario, which generates 35% of the residential municipal waste in Canada, indicates that approximately 423 kilotonnes of methane is available from landfills in Ontario, which corresponds to a total resource of 20 PJ. It is estimated that half of this quantity (10 PJ) could technically be collected. On a national level, the federal government plans to double the present capture of landfill gas. Extrapolated to Ontario this represents a practical resource of 9.6 PJ.

#### SEWAGE GAS

During the treatment of urban and industrial wastewater, recovered sewage gas can be used for energy purposes. Over 78% of Canadians are now using sewage systems connected to some type of wastewater treatment plant. In most cases, these plants use some of the methane produced during decomposition to heat their digesters. In at least nine plants, the methane is used in a cogeneration mode. The total installed capacity is estimated at 17 MW with an estimated annual generation of 58 GWh.<sup>44</sup>

Sewage sludge is a residual product from the treatment of urban and industrial wastewater. In Canada approximately 388,700 tonnes of sewage sludge are produced every year<sup>45</sup>. About 43% of these bio-solids are applied



to land, 47% are incinerated and 4% are sent to landfill. Because of the high moisture content, combustion generally takes place without net energy recovery.

No data was found on the potential energy captured in sewage gas from wastewater treatment. However, assuming 35% of Canada's sewage sludge and gas are released in Ontario, and assuming that one tonne of sewage sludge indicates a quantity of 6 GJ of energy from the sewage gas, the total resource of sewage gas is 0.8 PJ. The technical and practical resources are estimated at 0.6 and 0.4 PJ, respectively.

#### 4. Overview: the total, technical, and practical resources available

Table 9 summarizes the total, technical and practical biomass resource in Ontario expressed in PJ (the total resource is equal to 848.5 PJ of primary energy).

The total resource represents the total quantity of biomass that is potentially available, not taking into account environmental, technical and logistical considerations.

**TABLE 9**

Overview of the resource availability of biomass in Ontario (PJ, primary energy)

Supply sector	Type	Total resource	Technical resource	Practical resource
Forestry	Spent liquor and waste wood	377	229	83 <sup>a</sup>
	Bark			29
	Fuel wood			16.7
	Sawdust			13.7
	<b>Subtotal</b>			<b>142.4</b>
Agriculture	Energy crops	103	103	103
	Field crop residues	113	64	17
	Grains and grain milling residues	99	5.0	5.0
	Livestock manure	45	19	4.8
	<b>Subtotal</b>			<b>129.8</b>
Organic waste	Landfill gas	20	10	9.6
	Waste wood	4.7	4.7	3.8
	Residues from food industry	50	10	2.3
	Sewage sludge	0.8	0.6	0.4
	Biodegradable municipal waste	36	0	0
	<b>Subtotal</b>			<b>16.1</b>
<b>Total</b>		<b>848.5</b>	<b>445.3</b>	<b>288.3</b>

Note:

<sup>a</sup> This resource estimate from NRCan appears somewhat high given the energy content of black liquor. It may include imported wood, recycled paper, and a possible double counting of some of the bark and sawdust component indicated under the forestry sector. This figure requires further analysis.

The technical potential, representing the quantity of biomass that could be obtained in an environmentally-sustainable way with the help of state-of-the-art technologies, is estimated at 445 PJ of primary energy.

The practical potential does not take into account financial constraints, such as low heat and electricity prices, or high technology costs. However, it does take into account avoiding conflicts with existing uses of biomass. The practical potential of 288 PJ shows the resource that could be practically realized within a timeframe of 10 years. Of this resource, approximately 142 PJ would come from the forest sector while 130 PJ would come from the agricultural sector and 16 PJ from the waste recovery sector from urban areas. The estimates of incremental bioenergy would be 20 PJ from the forest sector, 130 PJ from the agricultural sector and 10 PJ from the urban waste sector, for a total of 160 PJ.

#### 5. Ontario's achievable biomass contribution

The contribution of biomass to the energy supply is divided into a short-term and long-term component. The long-term contribution is referred as the "achievable contribution," and the short-term contribution is referred as the "estimated contribution".

- The achievable contribution shows the amount of bio-energy that can be generated within 10–20 years with present and promising new technologies and with substantial financial incentives using the biomass types and volumes indicated as the practical resource.
- The estimated contribution shows the amount of bio-energy that can be generated within four years with present technologies and with modest financial incentives using the biomass types and volumes indicated as the practical resource.

##### 5.1 ACHIEVABLE CONTRIBUTION (2010–2020)

Table 10 shows the achievable contribution, utilizing the practical resource with the most efficient technologies. For power generation combined heat and power systems are used as the preferred technology.

The achievable contribution consists of 14.7 TWh (53 PJ) of electricity and 169 PJ of heat, in total 69.0 TWh (222 PJ) of secondary energy. About 14.7 TWh of

electricity can be generated, which corresponds with a generating capacity equivalent to 2,450 MW. In this scenario, 47.0 TWh (169 PJ) of heat is also produced, part of which could displace large amounts of grid power by substituting for electrical heating in residential applications. About 288 PJ of biomass is utilized. It corresponds roughly with 16.1 million tonnes of biomass per year. This resource can be obtained and utilized in a sustainable way, but care should be taken to meet all conditions of environmentally-sound production.

## 5.2 ESTIMATED CONTRIBUTION (2007)

The estimated contribution takes into account present use of bio-energy, market conditions and financial/economic factors, and could be realized in 2007. The following assumptions have been made:

- The present use of waste wood and black liquor is estimated at 83 PJ. Note that the black liquor is combusted not only for heat production, but primarily for recovery of chemicals dissolved in the liquor. Therefore, it is not known whether in the present situation all heat produced in this sector is used efficiently, or partly wasted. However, for the determination of the estimated contribution it is

assumed that 15% CHP and 85% heat generation is applied, and that all resulting heat and electricity can be used in the process.

- CHP is a relatively expensive application. It is assumed that 85% of the bark is combusted for heat production and that 15% is used for CHP.
- 16.7 PJ of wood fuels is presently used in households. It is expected that this situation will not change.
- Sawdust is sold on the Ontario market for heat production and burned as sawdust or wood pellets.
- About 50% of the available straw type agricultural residues are used for heat generation, replacing electricity, heating oil and propane. Collection and pre-treatment systems have to be implemented, which will take time.
- About 10% of the potential for energy crops is developed mainly for domestic heat production, replacing mainly electricity, heating oil, propane and natural gas. It is assumed that production is low in the initial years, as some time is needed for establishment of energy crops and to introduce densification and combustion equipment.
- 20% of the practical resource of manure is utilized for CHP production, assuming that the relatively

**TABLE 10**

Overview of achievable contribution of biomass in Ontario (PJ)

Supply sector	Type	Practical resource	Utilization	Used biomass	Application	Power	Heat
		PJ <sub>prim</sub>	%	PJ <sub>prim</sub>		PJ <sub>sec</sub>	PJ <sub>fuel</sub>
Forestry	Bark	29	50%	14.5	H		12.3
			50%	14.5	CHP <sup>a</sup>	4.4	6.5
	Spent liquor and waste wood	83	100%	83	CHP	24.9	37.4
	Sawdust	13.7	100%	13.7	H <sup>b</sup> (wood pellets)		11.6
	Fuel wood	16.7	100%	16.7	H		14.2
Agriculture	Agricultural residues	17	50%	8.5	H		7.2
			50%	8.5	CHP	2.6	3.8
	Energy crops	103	50%	51.5	H		43.8
			50%	51.5	CHP	15.5	23.2
	Grains and Milling residues	5.0	100%	5.0	H		4.3
Livestock Manure	4.8	100%	4.8	CHP (anaerobic digestion) <sup>c</sup>	1.4	2.2	
Organic waste	Residues from food industry	2.3	100%	2.3	CHP	0.7	1.0
	Waste wood	3.8	100%	3.8	CHP	1.1	1.7
	Landfill gas	9.6	100%	9.6	P	2.4	
	Sewage sludge	0.4	100%	0.4	CHP (anaerobic digestion) <sup>c</sup>	0.1	0.2
<b>Total</b>		<b>288.3</b>		<b>288.3</b>		<b>53.0</b>	<b>169.4</b>
<b>Total – TWh</b>						<b>14.7</b>	

Note

a CHP with an anticipated net electric and thermal efficiency of 30 and 45%, respectively.

b Heat applications have an assumed thermal efficiency of 85%, indicating an optimal match with the heat demand.

c Anaerobic digestion has an assumed net electric and thermal efficiency of 20 and 30%, respectively.

expensive technology is applied at the most suitable sites (i.e. those with a high heat demand and abundant manure supply).

- Used frying oil (food industry) can be co-combusted in natural gas heated power plants.
- Waste wood can be combusted for CHP production. The costs of the plant could be financed from fees for waste disposal; it is also assumed that highly efficient environmental control technology is applied to meet strict emissions limits.
- Presently, landfill gas is partly utilized, and the low electricity generating costs of 0.04 \$/kWh suggest that it is financially feasible to utilize the potential of 9.6 PJ primary energy optimally.
- Biodegradable municipal waste is only used for landfill gas production.

The estimated contribution is presented in Table 11 and indicates that about 2.5 TWh (9.1 PJ) of electricity can be achieved, which corresponds with a generating capacity of 426 MW.

More electricity generating capacity can be installed

if a financial incentive of 4 cents per kWh is available to make large biomass CHP production financially feasible.

In total, 113.7 PJ of heat is generated, of which 74 PJ (65%) with black liquor, wood waste and bark to be used as process heat, and 40 PJ (35%) with other biomass (wood fuels and pellets from sawdust, agricultural residues and energy crops) to be used for heating in the residential and commercial sectors (see Ontario Energy Appendix for a description of these sectors).

With the 40 PJ of non-process heat, a major reduction in the use of electricity heating oil and propane could be achieved given the favourable economics of biomass heat substitution for these commodities at current prices.

### 5.3 GROWTH QUICKENS IN NEW MARKETS

As sales of biomass systems, such as pellet stoves and boilers increase, reductions in prices can be achieved through economies of production. Other biomass systems can achieve faster market penetration rates if stable investment support mechanisms are provided in conjunction with clear guidelines for systems performance (to decrease the complexity of permitting processes).

**TABLE 11**

Overview of estimated contribution of biomass in Ontario (PJ)

Supply sector	Type	Practical resource	Utilization	Used biomass		Power	Heat
		PJ <sub>prim</sub>	%	PJ <sub>prim</sub>	Application	PJ <sub>sec</sub>	PJ <sub>fuel</sub>
Forestry	Bark	29	50%	14.5	H		12.3
Forestry	Bark	29	85%	24.7	H		17.3
			15%	4.4	CHP <sup>a</sup>	1.3	2.0
	Spent liquor and waste wood	83	85%	70.6	H		49.4
			15%	12.5	CHP	3.8	5.6
			100%	13.7	H <sup>b</sup> (wood pellets)		9.6
Fuel wood	16.7	100%	16.7	H		11.7	
Agriculture	Agricultural residues	17	50%	8.5	H		6.0
	Energy crops	103	10%	10.3	H		7.2
	Grains and Milling residues	5.0	100%	5.0	H		3.5
	Livestock Manure	4.8	20%	1.0	CHP (anaerobic digestion)	0.3	0.4
Organic waste	Residues from food industry	2.3	70%	1.6	P (co-combus-tion) <sup>c</sup>	0.6	
	Waste wood	3.8	50%	1.9	CHP	0.6	0.9
	Landfill gas	9.6	100%	9.6	P	2.4	
	Sewage sludge	0.4	100%	0.4	CHP (anaerobic digestion)	0.1	0.2
<b>Total</b>		<b>288.3</b>		<b>180.9</b>		<b>9.1</b>	<b>113.7</b>
<b>Total – TWh</b>						<b>2.5</b>	

Note.

a CHP with an anticipated net electric and thermal efficiency of 30 and 45%, respectively.

b Heat applications have an assumed thermal efficiency of 70%.

c Co-combustion of used frying oil is possible in a natural gas or oil fired electricity plant with an estimated efficiency of 40%.

## 6. Policies, mechanisms, and incentives to enhance biomass implementation

The implementation of biomass resources, as all other renewable energy sources, requires stable investment conditions. These conditions can be established through renewable energy mechanisms, which can be specifically tailored to increase market penetration of the most promising biomass technologies. This strategy is currently being used in Germany to support the development of anaerobic digestion of farm manure. Through this strategy, Germany has achieved the highest market penetration of that technology in Europe, while other European countries that have a similar resource base but lack renewable energy mechanisms (e.g. United Kingdom) have not achieved positive results.<sup>46</sup>

Adoption rates for smaller biomass systems for heat generation only (e.g. pellet stoves and boilers) will increase if supporting mechanisms are facilitated. The province should secure support from the federal government to establish a revolving loan system to provide low interest loans to enable home and business owners currently relying on electric heat, oil, natural gas and propane to purchase these new biomass appliances. Provincial and federal cooperation in this area constitutes a natural fit under common efforts to decrease greenhouse gas emissions and sustainable cities agendas.

Through the use of renewable energy mechanisms and a revolving loan system to support biomass heating systems, Ontario can establish a stable biomass market that will enable farmers and forestry operators to profit from their residues, energy crops and biomass products. Municipalities also need to provide leadership in helping develop district-heating systems to support their forest and agricultural resource-based communities.

The development of an integral biomass action plan to address issues such as financial incentives, public awareness, technology development, permits and procedures is essential for accelerating the development of biomass.

## 7. Conclusions, recommendations and further research

Analysis of Ontario's biomass potential shows that a total capacity of 426 MW of biomass-generated electricity could exist in Ontario by 2007 and 2,450 MW between 2010-2020. This capacity is higher than estimated in two recent studies. The report *Power to the Future* estimates that in 2020 the equivalent of 800 MW of biomass capacity can be installed in Ontario.<sup>47</sup> The report *Tough Choices* estimates that new biomass energy could provide the equivalent of an additional 1,700 MW of power.<sup>48</sup>

The difference in results can be explained by the fact that in this study, the biomass resource was investigated in more detail by covering several sectors that could supply additional biomass. In this report, the agricultural sector was identified as having the potential to create a large new energy supply that could make a significant contribution to Ontario's energy supply.

Provincial biomass resources and contributions were estimated with the best information presently available. However, the province needs to develop a model that incorporates economic effects of different resource-technology combinations in detail to derive accurate financial support instruments and detailed policy development.

The province will also benefit from commissioning follow-up studies to accurately estimate the quantities of residues from the forestry sector and its related industries, an area where not much information is currently available in Ontario.

Finally, in the pulp and paper industry significant amounts of biomass are currently used and it would be quite useful to investigate whether the biomass is utilized efficiently, and to determine if further optimization is possible, for instance by the introduction of CHP-plants for black liquor and bark.

Through follow-up studies, the province will achieve a comprehensive scenario covering all relevant biomass options and their pertinent caveats, which constitutes an essential step to formulate sustainable transition paths.

### QUEBEC COMPANY TURNS BIOMASS INTO ENERGY

A new form of renewable energy that turns fast growing grasses into a low-cost, environmentally-friendly means of heat energy is changing the rural energy market in Quebec.

Dell-Point Technologies of Blainville, Quebec, has designed a biomass fuel in the form of pellets made from switchgrass. Dell-Point tested various agricultural biofuels for producing pellets. It found switchgrass to be the most economical as it lowered processing costs by being easier to pellet and required minimal drying compared to wood. Pelleted switchgrass burns at the same efficiency as oil in a high efficiency oil furnace.



The pellets are burned in stoves, much like a wood or gas stove. Most pellet stoves are vented through a wall as compared to their wood counterpart. A hopper on the back of the stove can hold up to 60 pounds of fuel, which is then automatically fed to the combustion chamber, according to how much heat is required. Pellet fuel is easier to load and store than wood and has a much longer burning cycle. The pellet stoves are equipped with blowers that force hot air into the room through a heat exchanger located on the front of the stove.

The technology reduces space heating costs by 50 percent or more. Switchgrass pellets are only half the cost of conventional fuels for farmers.



## Biomass Appendix

Table 1 shows an estimate of the costs of landfill gas utilization, and co-combustion which total 4.5 and 6 cents/kWh. The cost of the landfill gas is set at zero as it is assumed that the owner of the landfill site receives a waste disposal fee. Options such as CHP-combustion are

more expensive (11 cents/kWh). Because anaerobic digestion is generally applied at a relatively small scale its cost is estimated at 17 cents/kWh which although makes it a more expensive option, but one that can be more easily implemented because of its small scale, the availability of manure, and demand for heat at farm level.

**TABLE 1**  
Costs of electricity generation with biomass

		Co-combustion with coal	Large CHP- combustion	Landfill gas	Anaerobic digestion (manure)
Capacity	MWe	50	30	1	0.04
Investment costs	\$/kWe	500	3,000	1,750	8,000
Operational time	hours/year	7,500	7,500	7,000	6,500
Energy content	GJ/ton	15	15	–	–
Fuel costs	\$/ton	90	90	0	0
Fuel costs	\$/GJ	6	6	–	–
Electric efficiency	%	40%	30%	25%	20.0%
Thermal efficiency	%	0%	45%	0%	30%
Electricity production	MWhe	375,000	225,000	7,000	260
Saleable heat production	GJ	0	1,215,000	0	1,404
Lifetime on investment	years	10	10	10	10
Discount rate	%	8%	8%	8%	8%
Total investment	\$	25,000,000	90,000,000	1,750,000	320,000
Annual capital costs	\$	3,725,737	13,412,654	260,802	47,689
Annual O&M costs (7-10% of ann. capital costs)	\$	260,802	938,886	26,080	4,769
Biomass costs	\$	20,250,000	16,200,000	0	0
Total production costs	\$	24,236,539	30,551,540	286,882	52,458
Production costs electricity (excl. sale of heat)	\$/kWh	0.065	0.136	0.041	0.202
Sales price heat	\$/GJ	–	9	–	9
Income from sold heat	\$	–	10,935,000	–	12,636
Production costs electricity (incl. sale of heat)	\$/kWh	0.065	0.087	0.041	0.153

TABLE 2

Source data and analysis for Figure 3: solar energy collection and fossil fuel energy requirements of Ontario crops, in giga-joules (GJ) per hectare

Crop	Yield <sup>e</sup> (ODT/ha)	Energy content (GJ/ODT)	Fossil energy consumed/tonne produced (GJ/ODT)	Fossil energy consumed/ ha of production (GJ/ha)	Energy content/ha (GJ/ha)	Energy content/ha less fossil energy consumed/ha production (GJ/ha)
Oats	2.1	19.1 <sup>a</sup>	2.5 <sup>b</sup>	5.25	40.11	34.86
Rye	2.2	(19.0) <sup>g</sup>	2.5 <sup>b</sup>	5.50	41.80	36.30
Soybeans	2.2	23.8 <sup>a</sup>	2.0 <sup>h,f</sup>	4.40	52.27	47.87
Canola	2.2	25.0 <sup>h</sup>	2.5 <sup>b</sup>	5.50	55.00	49.50
Barley	3.2	(19.0) <sup>g</sup>	2.5 <sup>b</sup>	8.00	60.80	52.80
Winter wheat	4.1	18.7 <sup>a</sup>	2.5 <sup>b</sup>	10.25	76.67	66.42
Grain corn	5.2	18.8 <sup>a</sup>	3.5 <sup>h,f</sup>	18.20	97.76	79.56
Tame hay	6.3	17.9 <sup>a</sup>	0.8 <sup>b</sup>	5.04	112.77	107.73
Switchgrass	9.0 <sup>i</sup>	19.0 <sup>c</sup>	0.8 <sup>d</sup>	7.20	171.00	163.80

Notes on sources:

a. Agricultural Utilization Research Institute. AURI Fuels Initiative. (<http://www.auri.org/research/fuels/fuel.htm>).

b. Estimates based on: Southwell, P.H. and T.M. Rothwell. 1977. *Report on analysis of output/input energy ratios of food production in Ontario*. School of Engineering, University of Guelph. Contract Serial No. OS276-00048.

c. Samson, R. and P. Duxbury. 2000. *Assessment of Pelletized Biofuels*. REAP-Canada. (<http://www.reap-canada.com/Reports/pelletaug2000.html>).

d. Girouard P., C. Zan, B. Mehdi, and R. Samson. 1999. *Economics and Carbon Offset Potential of Biomass Fuels: Final Report*. Federal Panel on energy Research and Development (PERD). Contract 23341-6-2010/00 1/SQ.

e. Ontario Ministry of Agricultural and Food. 2001. *Ontario Crop Statistics 1997-2001*. (<http://www.gov.on.ca/OMAFRA/english/stats/crops/index.html>).

f. Swanton C.J., S.D. Murphy, D.J. Hume, D.R. Clements. 1996. *Recent Improvements in the Energy Efficiency of Agriculture: Case Studies from Ontario, Canada*. *Agricultural Systems*. 52: 399-418.

g. Estimate based on energy contents of other cereal grains. REAP-Canada.

h. Personal communication from Dell-Point Technologies.

i. Yield estimate from REAP-Canada based on pre-commercial field studies.

## BIOMASS CHAPTER NOTES

- 1 Samson R., M. Drisdelle, L. Mulkins, C. Lapointe, and P. Duxbury. (2000a). *The Use of Switchgrass Biofuel Pellets as a Greenhouse Gas Offset Strategy*. Bioenergy 2000. Buffalo, New York: bioenergy 2000. Available at: <http://www.reap-canada.com/Reports/bioenergy2000Aug2.html>
- 2 All figures are for 2001 and are from Ericsson, K., Huttunen, S., Nilsson, J. and Svenningsson, P. (2004). Bioenergy policy and market development in Finland and Sweden. *Energy Policy*, 32 (15), 1707–1721.
- 3 Ibid.
- 4 Sims, R., Richards, K. (2004). *Bioenergy for the global community*. *Renewable Energy World*, 7 (1), 8–133.
- 5 Jannasch, R., R. Samson, A. De Maio and T. Helwig. (2001). Switchgrass Fuel Pellet Production in Eastern Ontario: A Market Study. REAP-Canada Final Report to CANADAPT and the Agricultural Adaptation Council of Ontario. Ottawa: REAP-Canada.
- 6 Turkenburg et al. (2001). *World Energy Assessment: Energy and the Challenge of Sustainability*. New York: UNDP.
- 7 Jannasch et al. (2001) op.cit. note 5.
- 8 Source: Natural Resources Canada, Office of Energy Efficiency available online at: [http://oeel.nrcan.gc.ca/Neud/dpa/trends\\_res\\_on.cfm](http://oeel.nrcan.gc.ca/Neud/dpa/trends_res_on.cfm)
- 9 A series of case studies and backgrounders on the different types of biomass heating systems found in Ontario and in other provinces are available on the Natural Resources Canada web site. They include reports on:
  - Residential Wood heating  
[http://canren.gc.ca/prod\\_serv/index.asp?CaId=103&PgId=576](http://canren.gc.ca/prod_serv/index.asp?CaId=103&PgId=576)
  - Wood Chip Heating systems for farms and small commercial applications  
[http://www.canren.gc.ca/prod\\_serv/index.asp?CaId=130&PgId=729](http://www.canren.gc.ca/prod_serv/index.asp?CaId=130&PgId=729)  
[http://www.canren.gc.ca/prod\\_serv/index.asp?CaId=162&PgId=860](http://www.canren.gc.ca/prod_serv/index.asp?CaId=162&PgId=860)  
[http://www.canren.gc.ca/renew\\_ene/index.asp?CaId=47&PgId=738](http://www.canren.gc.ca/renew_ene/index.asp?CaId=47&PgId=738)
  - District heating systems  
[http://canren.gc.ca/prod\\_serv/index.asp?CaId=184&PgId=1091](http://canren.gc.ca/prod_serv/index.asp?CaId=184&PgId=1091)  
[http://www.canren.gc.ca/renew\\_ene/index.asp?CaId=47&PgId=975](http://www.canren.gc.ca/renew_ene/index.asp?CaId=47&PgId=975)  
[http://www.canren.gc.ca/renew\\_ene/index.asp?CaId=47&PgId=956](http://www.canren.gc.ca/renew_ene/index.asp?CaId=47&PgId=956)  
[http://www.districtenergy.org/CHP\\_Case\\_Studies/University\\_of\\_Iowa.pdf](http://www.districtenergy.org/CHP_Case_Studies/University_of_Iowa.pdf)
- 10 A cogeneration case study can be found at: [http://www.canren.gc.ca/renew\\_ene/index.asp?CaId=47&PgId=1194](http://www.canren.gc.ca/renew_ene/index.asp?CaId=47&PgId=1194)
- 11 The first generation of BIGCC systems shows high unit capital costs. Depending on the scale, prices are in the range of \$4,000–7,000 per kW, but cost reduction potential is considerable -capital costs might come down to \$1,500–2,800 per kW.
- 12 Anaerobic digestion also takes place in the treatment of urban and industrial waste waters. Sewage gas is recovered as part of the process, which can be used for energy purposes. Usually the recovered heat is used at the treatment plants. More background information can be found at: [http://www.canren.gc.ca/prod\\_serv/index.asp?CaId=170&PgId=970](http://www.canren.gc.ca/prod_serv/index.asp?CaId=170&PgId=970)
- 13 Biogas production occurs naturally, amongst others in swamps and lakes when conditions are right. In a tank or container conditions can be created to optimize biogas production from manure and organic materials. Biogas production also takes place in landfills. The biogas is then usually called landfill gas.
- 14 See page 126 of Tijmensen, M., van den Broek, R. (2004). Clean power from farm waste: international experiences with anaerobic digestion of farm manure. *Renewable Energy World*, 7 (2), 124–131.
- 15 Ibid.
- 16 A NRCan case study on landfill gas can be found at: [http://www.canren.gc.ca/renew\\_ene/index.asp?CaId=47&PgId=1121](http://www.canren.gc.ca/renew_ene/index.asp?CaId=47&PgId=1121)
- 17 Tampier, M. (2002). *Promoting Green Power in Canada, Green Power Policies: A Look Across Borders*. Toronto: Pollution Probe. Available at [www.pollutionprobe.org/Reports/greenpower.pdf](http://www.pollutionprobe.org/Reports/greenpower.pdf)
- 18 Von Hammerstein. (2004). Facing the future: what new policy will mean for wind in Germany. *Renewable Energy World*, 7 (3), 88–97.
- 19 See Sims, R. (2003). Bioenergy to mitigate for climate change and meet the needs of society, the economy and the environment. *Mitigation and Adaptation Strategies for Global Change*, 8 (4), 349–370 and Sims and Richards (2004) op.cit note 4.
- 20 This chapter estimates that Ontario could generate 2,500 GWh/year by 2007 and 14,700 GWh/year by 2020 from biomass sources.
- 21 Agriculture and Agri-Food Canada's February 2004 Forecast – Farm Cash Receipts, Expenses and Income for 2002 and 2003 available at [www.agr.gc.ca/spb/fiap-dpraa/publications/frcstprev/forcst03\\_e.php](http://www.agr.gc.ca/spb/fiap-dpraa/publications/frcstprev/forcst03_e.php)
- 22 The Walkerton Inquiry revealed that the key physical source of contamination behind the Walkerton tragedy was manure that had been spread on a farm near a drinking well; the manure was contaminated with *E.coli* bacteria and *Campylobacter* strains, which unfortunately became the source of a deadly human outbreak of *E.coli* in the Town of Walkerton in 2000. O'Connor, D. (2002). *Report of the Walkerton Inquiry*. Toronto: Ontario Ministry of the Attorney General.
- 23 Lowe et al. (1996). Penner et al. (1997) provide estimates to derive the total (woody) biomass resource from



- numbers of timber productive wood and distinguish two productivity classes of forest. Productivity class I is forestland incapable of producing a merchantable stand. Productivity class II is forestland capable of producing a merchantable stand within a reasonable length of time, and can be related to Canada's Forest Inventory. See: Lowe, J.J., K. Power, and S.L. Gray, (1996). *Canada's Forest Inventory 1991: the 1994 version. An addendum to Canada's forest inventory 1991. CFS Information report BC-X-362E*. Victoria: Canadian Forest Service. Penner, M., et al. (1997). *Canada's Forest Biomass Resources: Deriving estimates from Canada's Forest Inventory*, Victoria: Pacific Forestry Centre.
- 24 Derived with help of average biomass density (87 t/ha) and timber productive area (42.2 mln ha) as stated in Penner et al. (1997) and Lowe et al. (1996) op.cit. note 23.
- 25 Source: National forest database program <http://www.nfdp.ccfm.org/>
- 26 These factors are investigated in detail in Penner et al. (1997) op.cit note 23.
- 27 Courtesy of BTG
- 28 For more details see [www.fsc.org](http://www.fsc.org)
- 29 Other technologies like black liquor gasification are described in Tam, P., et al., *Forest sector table: assessment of gasification technologies and prospects for their commercial application*. 1999, Forest Sector Table National Climate Change Process: Richmond, B.C. Black liquor can lead to emissions of dioxins and furans (dioxins are known carcinogens). For more information see Uloth, V. van Heek, R. (2002). *Dioxin and Furan Emission Factors for Combustion Operations in Pulp Mills*, Report Prepared for Environment Canada. PAPRICAN: Prince George, BC. Available at: [www.ec.gc.ca/pdb/npri/2002guidanceEmission\\_Factor\\_Report\\_for\\_Combustion\\_Ops\\_in\\_Pulp\\_Mills.pdf](http://www.ec.gc.ca/pdb/npri/2002guidanceEmission_Factor_Report_for_Combustion_Ops_in_Pulp_Mills.pdf)
- 30 Natural Resources Canada, Office of Energy Efficiency, Historical Databases – February 2003, retrieved May 2004 from [http://oeel.nrcan.gc.ca/Neud/dpa/comprehensive\\_tables/](http://oeel.nrcan.gc.ca/Neud/dpa/comprehensive_tables/)
- 31 Hatton, T. (1999). *Canada's Wood Residues, a profile of current surplus and regional concentrations*. Canadian Forest Service, Industry, Economics and Programs Branch. Available at [www.nccp.ca/NCCP/pdf/Canada's\\_Wood\\_Residues.pdf](http://www.nccp.ca/NCCP/pdf/Canada's_Wood_Residues.pdf)
- 32 Natural Resources Canada, Office of Energy Efficiency, Historical Databases – February 2003, retrieved May 2004 from [http://oeel.nrcan.gc.ca/Neud/dpa/comprehensive\\_tables/](http://oeel.nrcan.gc.ca/Neud/dpa/comprehensive_tables/)
- 33 Table derived using: Tam, P., et al. (1999). *Forest sector table: assessment of gasification technologies and prospects for their commercial application*. Richmond: Forest Sector Table National Climate Change Process; National forest database programme <http://www.nfdp.ccfm.org>; and Natural resources Canada, Office of Energy Efficiency, Historical Databases – February 2003, retrieved May 2004 from [http://oeel.nrcan.gc.ca/Neud/dpa/comprehensive\\_tables/](http://oeel.nrcan.gc.ca/Neud/dpa/comprehensive_tables/)
- 34 Madakadze C, Coulman BE, McElroy AR, Stewart KA and Smith DL. (1998). Evaluation of selected warm season grasses for biomass production in a short season area. *Bio Resource Technol*, 65, 1–12. Arvid Boe, South Dakota State University, personal communication.
- 35 Corn stover are the stalks and leaves and cobs of the corn plant.
- 36 Helwig, T., et al. (2002). *Agricultural biomass residue inventories and conversion systems for energy production in Eastern Canada*. Ste. Anne de Bellevue, Quebec: Resource Efficient Agricultural Production (REAP).
- 37 Ibid.
- 38 Germany and Denmark have accumulated significant experience with anaerobic digestion. Digested manure can be used as fertilizer avoiding the loss of important nutrients. Although the manure of chickens and turkeys is suitable for combustion and gasification using emission controls (as it is done in the Netherlands and the United Kingdom), its incineration prevents its application as a fertilizer.
- 39 Tampier, M., E. Bibeau, and P.A. Beauchemin. (2003). *Identifying environmentally preferable uses for biomass resources, draft stage 1 report: identification of feedstock-to-product threads*. North Vancouver, B.C: Envirochem services Inc.
- 40 Source: Statistics Canada: Disposal of waste by source, by provinces and territories available at: [www.statcan.ca/english/Pgdb/envi25a.htm](http://www.statcan.ca/english/Pgdb/envi25a.htm)
- 41 Ibid.
- 42 See Environment Canada's online article: 'Harnessing the Power of Landfill Gas'. Available at [http://www.ec.gc.ca/science/sandemay99/article1\\_e.html](http://www.ec.gc.ca/science/sandemay99/article1_e.html)
- 43 Pneumatics, S. (2003). *Renewable Energy in Canada, Status Report 2002*. Renewable Ottawa: NRCan. Available at [www2.nrcan.gc.ca/es/oerd/english/View.asp?x=700](http://www2.nrcan.gc.ca/es/oerd/english/View.asp?x=700)
- 44 Ibid.
- 45 Tampier et al. (2003) op. cit. note 39.
- 46 Although the U.K. has a comparable manure production to Germany's, it currently has only a few demonstration plants (both countries have two of the largest manure production rates of western Europe); see Tijmensen and van der Broek (2004) op.cit. Note 14.
- 47 This estimation is based on the following information: 100 MWe of generating capacity could be provided through landfill gas recovery; between 200 and 500 MWe of capacity might be provided through the use of methane from anaerobic digestion of various waste streams; and the remaining needed capacity could be provided by combustion of agricultural and wood waste.
- 48 It is stated that biomass energy is generated primarily from burning waste products such as landfill gas, wood chips from forestry operations and animal waste. The number is not further justified.

# 5

## Geothermal Heat Pumps

### Summary

**GEOTHERMAL HEAT PUMPS ARE** the most cost-effective option to provide space heating and cooling in Ontario.

The implementation of geothermal heat pumps is a key strategy to displace electricity use and fossil fuels currently used for heating and cooling in residential and institutional/commercial buildings.

By displacing electricity use and fossil fuels, the technology represents a very cost-effective greenhouse gas mitigation strategy.

Geothermal heat pumps can be used across the province and are especially attractive for new buildings.

Manitoba Hydro has become a Canadian leader in deploying geothermal heat pumps, and provides an exemplary implementation template for Ontario.

The province should use its procurement ability to purchase geothermal heat pumps for provincial and municipal buildings to facilitate a market transformation in the institutional/commercial building sector.

The federal and provincial governments should collaborate, as part of their climate change mitigation efforts, to implement a revolving loan system to provide access to interest-free loans for the purchase of geothermal heat pumps.

### 1. Background

Geothermal heat pumps are one of the least-understood renewable energy options in Ontario partly because the technology (once installed) is out of sight, and partly because the industry interchangeably uses for the same concept a variety of terms: earth energy, GeoExchange, and ground-source heat pump.

Geothermal heat pumps are the most energy-efficient, cost-effective, and environmentally- friendly home heating and cooling systems available.<sup>1</sup> Heat pump technology works by moving heat out of, or back into the earth. Geothermal units are connected to the earth through pipes buried under a lawn, landscaped area, or even the building itself.

For this chapter, the term ‘geothermal heat pump’ (GHP) will be used to refer to ground-coupled heat exchangers that extract the stored energy readily available from the soil to meet all the needs for space heating, cooling and water heating (potable, service or pre-heat) of residential, institutional, commercial, and industrial buildings in the province.<sup>2</sup>

Of the solar radiation that reaches the earth, NASA estimates that more than half is absorbed into the near-surface land and water. GHP taps into this heat source below the frost line and ‘upgrades’ the temperature in a compressor before it is delivered as hot air or hot water. The secret to this technology is to collect small ‘packets’ of solar heat available from the soil, and to concentrate this thermal energy for use within a building’s space.

This transfer of solar heat from the earth is achieved through the use of ground loops that can be installed in one of two basic configurations:<sup>3</sup>

- An ‘open loop’ that takes water from an aquifer, well or lake directly to a compressor, which extracts two to four degrees Celsius (°C) of thermal heat (or adds, in cooling mode) before the water is returned to its source<sup>4</sup>;
- A ‘closed loop’ that circulates a diluted antifreeze through a pipe to absorb heat from the surrounding soil. The pipe is laid horizontally or, if the available

footprint is small, a 'coiled' loop is used to increase surface area for thermal transfer or, if land is very limited, vertical boreholes are drilled to transfer heat from deeper soil.

For cooling, the system is reversed, and heat from the building is transferred into the antifreeze or water for rejection into the outside 'heat sink,' in the same manner as a refrigerator takes heat from food and transfers it into a kitchen.

The amount of solar heat that is absorbed into the earth can be calculated by solar incidence charts. The ability of the soil to transfer this heat to the pipe (or its ability to absorb heat in cooling mode) can be assessed by a thermal conductivity analysis of the soil in which the pipe is buried.

During winter, the temperature of the earth's subsurface is warmer than average ambient (outdoor) air temperature, and cooler during summer. Below the frost line (average depth of 1.2 m across most of southern Ontario), the relatively constant temperature of the earth is close to the long-term mean annual ambient temperature, i.e.: 4° to 12° C throughout the year. Space conditioning systems in Toronto are designed to meet temperatures of -17.1° C in winter and 28.8° C in summer, and GHPs use this temperature differential to provide heating and cooling.

GHPs require electricity to power three system components: a circulating pump for the fluid in the loop; a compressor to execute the heat exchange process; and a distribution system for the hot air or radiant water. Overall efficiency is determined by a coefficient of performance (COP), which measures the amount of heat energy delivered to the space, divided by the electricity needed to operate the components. A COP of 3.0 means that 3 kW of usable thermal heat energy is transferred from the soil for every 1 kW of electricity consumed by components, for a net energy 'saving' of 2 kW.<sup>5</sup>

A variation of GHP technology is called Direct Expansion (DX), which uses copper pipe to circulate a refrigerant, rather than a liquid antifreeze. DX technology has a higher thermal transfer, but is a more expensive option and creates environmental concerns because it relies on a refrigerant buried in the earth.

The Canadian Standard Association accepted a standard in 2001 (CSA C4480), which regulates design and installation of both residential and commercial systems.



FIGURE 1 Residential GHP system

This standard has a section on 'underground thermal energy storage' to govern the use of caverns or aquifers to enhance heat transfer by use of a storage source/sink.

GHP is a 'distributed resource,' as it relies on energy that is sourced at or near the point of consumption. It does not require a centralized distribution system (e.g. natural gas pipeline) and its ability to reduce total power consumption (compared with electric heating/cooling) reduces transmission infrastructure and reduces grid congestion.

### 1.1 COSTS

The cost to install GHP systems is difficult to estimate because each site is specific, but this section will assume a residential 'high-average' total installed retail price of \$20,000 for a new 2,000 ft<sup>2</sup> house in a Toronto or Ottawa subdivision, in a system designed to meet 100% of heating and cooling loads for space and domestic water.<sup>6</sup> Of this price, one-quarter (\$5,000) is attributed to internal components (heat exchanger, compressor, fans, pumps, water desuperheater, etc) and the balance (\$15,000) for excavation and installation of the outside loop. The GHP industry notes that installed prices can range from \$10,000 to \$23,000, depending on the type of soil and many other factors.<sup>7</sup>

In 1993, the Ontario Ministry of Environment and Energy estimated that GHP with a COP of 2.7 in a detached 2,000 ft<sup>2</sup> home in Toronto would cost \$6,000 to \$12,000 to install, and cost \$790 a year for heating and cooling, and another \$160 for water heating. It estimates the cost of heating with electric resistance would be \$1,820 plus \$490 for water heating.<sup>8</sup>

Manitoba Hydro offers a GHP loan of \$15,000 for installed systems and estimates the cost of a new system in a 2,000-ft<sup>2</sup> home at \$15,900 to \$18,000, compared with \$6,700 for electric baseboards; in a retrofit, GHP would cost

\$11,400 to \$16,500.<sup>9</sup> Annual space heating costs would be \$400 compared with \$1,001 for an electric furnace or electric baseboards, and \$1,253 for a conventional (60% efficiency) gas furnace and \$1,670 for a conventional oil furnace.<sup>10</sup>

The cost to install a GHP system in ICI facilities is difficult to estimate because building and occupant load profiles entail several distinct parameters. Analysis by Marbek (1999) found a low of \$35,800 for a curling rink to a high of \$756,336 for a seniors complex, both in Toronto.<sup>11</sup>

As far back as 1995, Natural Resources Canada estimated that in a detached home in Toronto it would cost \$285 to \$480 a year to operate an open loop GHP and \$295 to \$525 for a closed loop system (heating only) compared with \$740 to \$1,295 for an electric furnace.<sup>12</sup>

Using a 2004 cost comparison, Aquila Networks (now Fortis BC) estimates that a new single-family detached 2,000 ft<sup>2</sup> house in central British Columbia would require 20,000 kWh a year of heating/cooling, which would cost \$530 a year from a GHP system, \$1,244 from electric baseboard and \$1,100 from mid-efficiency (78%) natural gas. Hot water would cost \$142 with a GHP system, \$293 with electricity and \$273 with natural gas (for four occupants).<sup>13</sup>

In his budget of April 2004, Manitoba's Finance Minister said GHP could reduce heating costs by \$400 to \$800 a year compared with natural gas, and by \$600 compared with all electric heating.<sup>14</sup> Manitoba Hydro supports the technology because it reduces local electricity use and therefore facilitates exports of electricity at high profit, while gas ratepayers avoid costly extensions of infrastructure into less-populated areas.

Manitoba Hydro has increased its marketing and communications support for GHP, including provision of attractive incentives and on-bill financing, and the province has negotiated federal incentives.

The Manitoba geothermal industry last year achieved a 40% growth rate. Manitoba is now first in Canada in total installations of GHPs, representing 30% of total new Canadian installations last year. GHP units are also being installed widely in commercial buildings, arenas, schools and other public buildings.

GHP is the least expensive source for thermal energy, based on an index of competing heating fuels, according to the Geo-Heat Center in Oregon.<sup>15</sup> GHP would cost \$5.86 per million Btu of useful heating, compared with \$7.14 for natural gas, \$9.06 for fuel oil, \$9.54 for air-source heat pump, \$15.85 for propane and \$20.51 for electric resistance heat.

## 1.2 GHP DEVELOPMENT

The International Energy Agency's Heat Pump Centre estimates that there are 500,000 GHPs currently installed around the world, with an estimated 45,000 new units added each year.<sup>16</sup> Its June 2004 newsletter reports on 2003 sales in three European countries:<sup>17</sup>

- The Swedish Heat Pump Association says that 48,806 heat pumps were installed (not including 25,000 air-to-air systems), of which GHP sales increased 15% to a total of 31,586 units;
- Germany reports that the market for heating-only heat pumps increased by 17% over 2002, with 9,745 space heating and 3,776 DHW systems sold;
- Sales in Norway were 55,000 units compared with 21,300 in 2002 and 6,300 in 2001, the majority of which were air-to-air systems. The Ministry of Petroleum & Energy provided a 20% subsidy for heat pumps, which result in 17,000 GHP systems in 2003.

GHP became popular in the United States because it could provide an alternative cooling technology to electric air conditioning. In a 1993 report, the Environmental Protection Agency noted that GHP was the best choice of five technology options for heating/cooling in all locations because it offered the lowest annual operating costs and lowest annualized costs, and was best for cutting greenhouse gas emissions.<sup>18</sup> That report led to the investment of \$50 million (US) by governments and utilities (both private and public), and currently there are at least 21 states with financial incentives for GHP installations in the U.S.

The World Energy Council estimates that Canada had an installed capacity equivalent to 377,600 kW of low-temperature geothermal<sup>19</sup> in 2001, but there is no data available from the federal<sup>20</sup> or Ontario<sup>21</sup> governments for either existing capacity or thermal output from GHP.

The Earth Energy Society of Canada estimates that 35,000 systems have been installed across Canada, of which 30,000 are residential and the balance are institutional/commercial buildings. Its 'best guess' for Ontario's installations is 8,500 residential and 500 institutional/commercial building systems.<sup>22</sup>

Under a residential installation program funded by Ontario Hydro from 1990 to 1993, the Canadian Earth Energy Association administered the installation of 6,749 residential units in areas not served by natural gas.<sup>23</sup>

Currently, Fortis BC (formerly Aquila/West Kootenay Power) offers a rebate for residential and institutional/commercial building installations of GHP, and Manitoba Hydro offers a low-interest financing program for installations.

Some notable GHP facilities in Ontario include the University of Ontario Institute of Technology (one of the largest GHP installations on the continent); the new Parks Canada centre in Hamilton (the first in North America to use GHP with concrete piles); the Trustcan Realty office in downtown Toronto (the building was constructed above the boreholes to save land); Carleton University's aquifer thermal energy storage system; municipal water treatment facilities in Sudbury; and the Shadow Ridge subdivision near Ottawa that uses only GHP.

### 1.3 TECHNICAL CONSIDERATIONS

GHPs currently provide only space heating, space cooling and water heating. Models are under development to include refrigeration as part of the cycle. In addition to heating and cooling buildings, some of GHP's more unusual applications include crop drying, ice rink freezing, and road de-icing.

To assess the potential capacity for GHP in Ontario, the RETScreen software was used to model two basic building configurations.<sup>24</sup> A basic model examined a residence with 185 m<sup>2</sup> (2,000 ft<sup>2</sup>) of floor space and GHP with minimum efficiency installed in heavy damp soil (representative of most of southern Ontario); and a commercial building of 9,290 m<sup>2</sup> (100,000 ft<sup>2</sup>) using vertical boreholes on a low-efficiency unit in the same soil. Details are provided in the GHP Appendix.

To assess the potential contribution under a more mature market scenario, an advanced model increased insulation levels and upgraded heat pump efficiency, while the soil conductivity classification was increased one level.

Compared with a 'basic' Toronto/Ottawa residence that is heated and cooled by electricity, GHP can reduce power consumption by 59%<sup>29</sup>, which increases to 73% under an 'advanced' scenario<sup>30</sup> and 80% when an 'advanced' GHP home is compared with a current 'basic' unit.<sup>31</sup>

GHP is classified as an 'electric' heating technology because it requires electricity to power its components. The above model assumes that GHP will displace buildings with all electric heating and cooling, but it

should be noted that annual demand for electricity will increase if GHP is used to displace natural gas. However, each 'basic' residence would avoid combustion of 1,685 m<sup>3</sup> to 3,064 m<sup>3</sup> of natural gas each year.<sup>32</sup>

**TABLE 1**

GHP residential energy savings (annual kWh for space heating & cooling)

	Energy demand <sup>25</sup>	GHP consumption <sup>26</sup>	GHP 'saving'
<b>Basic residence</b>			
Toronto			
– heating	15,900	6,900	9,000
– cooling	13,600	5,000	8,600
Ottawa			
– heating	20,100	8,700	11,400
– cooling	11,000	4,300	6,700
<b>Annual average<sup>27</sup></b>	<b>30,300</b>	<b>12,500</b>	<b>17,850</b>
<b>Advanced residence</b>			
Toronto			
– heating	8,100	2,500	5,600
– cooling	15,000	3,500	11,500
Ottawa			
– heating	10,400	3,100	7,300
– cooling	12,300	3,100	9,200
<b>Annual average</b>	<b>22,900</b>	<b>6,100</b>	<b>16,800</b>

NOTE: these data are for space heating and space cooling only, and do not reflect water heating, which accounts for 21% of residential energy consumption in Ontario.<sup>28</sup> GHP can provide 100% of domestic hot water load with a minor increase in run-time.

**TABLE 2**

Institutional / Commercial / Industrial (ICI) Energy Savings (annual kWh for space heating & cooling)

	Energy demand	GHP consumption	GHP 'saving'
<b>Basic ICI</b>			
Toronto			
– heating	448,000	208,000	240,000
– cooling	838,300	234,300	604,000
Ottawa			
– heating	515,200	232,800	282,400
– cooling	685,200	194,700	500,500
<b>Annual average</b>	<b>1,243,300</b>	<b>434,900</b>	<b>813,400</b>
<b>Advanced ICI</b>			
Toronto			
– heating	461,600	157,000	304,600
– cooling	570,300	109,000	461,300
Ottawa			
– heating	567,700	185,200	382,500
– cooling	464,700	88,900	375,800
<b>Annual average</b>	<b>1,032,100</b>	<b>270,000</b>	<b>762,100</b>

## 1.4 BENEFITS OF GHP

### ECONOMIC BENEFITS

Geothermal energy is the cheapest option for space heating and cooling.<sup>33</sup> Operating and maintenance costs in institutional/commercial buildings are lower than any other space conditioning option.<sup>34</sup> In the residential sector, GHP can reduce space-conditioning costs compared with conventional heating and cooling options, and it can stabilize both conditioning costs and increase security of supply.<sup>35</sup> Low-grade thermal heat is less expensive per delivered energy unit than high-grade electricity, and the technology can meet heating and cooling demand with a more appropriate source of energy. In addition, GHP can complement utility demand curves and allow peak loads to be reduced by serving as a base-load supply. By eliminating the need for natural gas for space and water heating, fossil fuel reserves can be diverted to applications with a higher commercial value such as centralized electricity generation, production of hydrogen or for the export market.

### ENVIRONMENTAL

Compared with electric heating and cooling, GHP can reduce greenhouse gas emissions by up to 75% (depending on the fuel used for generation, when displacing carbon-based fuels the reductions are at the highest level).

### DISTRIBUTED RESOURCE

By reducing the need for high-capacity transmission towers and reducing congestion on the grid, geothermal energy works well in non-urban areas that lack a physical connection to a natural gas pipeline.

### DESIGN

GHP allows removal of roof-top chillers and boiling towers on institutional/commercial buildings, thereby reducing design constraints and allowing architects to increase the aesthetic appeal of a building. Once installed, both exterior and interior sections are invisible, eliminating any opposition to the technology on the basis of aesthetics.<sup>36</sup> The use of decentralized heat pumps minimizes the space required for a mechanical room and increases the percentage of usable space in a building. The technology is also well adapted for use in a 'net zero energy' building (for more details about net zero energy buildings see the solar power chapter).

### DURABILITY & SAFETY

Locating electro-mechanical components inside the building will minimize degradation from exposure to harsh weather conditions, while a buried loop experiences minimal degradation. The absence of exposed equipment reduces the risk of intentional or accidental damage, and the lack of combustion eliminates the need for on-site fuel storage and associated risk of explosion. The relatively stable run times of GHP reduces start-up pressures and other negative impacts on system life.

### COMFORT

The CSA standard requires acoustic insulation to ensure that there is virtually no noise from a system, and the absence of setback thermostats avoids the need for temperature reductions at night. The higher airflow of low-temperature air increases occupant comfort by reducing draughts, and GHP provides greater control over interior humidity and eliminates concerns over indoor air quality.

## 1.5 EMPLOYMENT

Currently, there are less than 15 companies in Canada involved exclusively in GHP. The balance includes HVAC (heating, ventilation, and air conditioning) companies that offer the technology as an option to conventional heating and cooling equipment. Of the 15, five are manufacturers or distributors, three are design firms and seven are installing contractor companies, with a total employment of 35 people.<sup>37</sup> Also, the equivalent of 50 person-years exist among 'part-time' contractors.<sup>38</sup>

Under the three-year Ontario Hydro program that resulted in the installation of 6,750 GHP units, the total number of registered contractors during that period was less than 300, of which half would have been involved on a 'full-time' basis for the duration of the program. At peak, it is estimated that each registered contractor had assistance from four additional workers (drillers, backhoe operators, etc).

Manitoba Hydro concludes that each 1,000 GHP residential installations result in \$15 million in construction-related activity and over 150 jobs.<sup>39</sup> Extrapolating these job creation figures to Ontario, where 125,000 GHP home systems could be installed, results in 18,750 jobs by 2007. By 2020, the installation of 341,000 GHP systems could result in up to 51,150 jobs.

These estimates provide a good general indication of the employment potential of this technology in Ontario. It is emphasized that a follow-up study is required to determine more precisely the economic co-benefits of GHP for the province.

### 1.6 ECONOMIC DEVELOPMENT

The majority of GHP cost is the labour to install the loop, which maximizes the local benefits of each installation (unlike natural gas where the bulk of the economic activity is transferred outside of the province). In a residential system, three-quarters of the total pre-tax price is allocated to loop configuration, design, trenching, fusing, purging, backfilling and permits (the polyethylene pipe is the only 'hard cost'), with the balance of cost for all interior components (hardware, wiring, distribution, etc). In institutional/commercial buildings the exterior portion is approximately two-thirds of total cost, which reflects the economies of scale on loop installation and the higher relative number of heat pumps. These averages exclude any retrofit work.

All labour is assumed to be local and, when combined with up to one-third of equipment costs (distributor and dealer markups, components manufactured in Canada, etc), means that 80% to 85% of the total system cost is classified as 'local content'. The level would be higher for domestically-manufactured heat pumps, which currently comprise less than 10% of sales. Loop trenching requires a backhoe operator (or a qualified well driller for vertical loops), while a trained contractor can fuse the pipe. Excluding design and supervision, only general skills are required for a residential installation.

Under the above scenario, an average \$20,000 residential system would contribute \$16,000 to \$17,000 to the local economy (excluding \$3,000 in PST/GST). The Ontario budget tabled in May 2004 announced the intention to remove GHP from retail sales tax, to place it on an equal footing with solar thermal systems, which were exempted in 2003.

## 2. Ontario's GHP resource

Eighty percent of Ontario's population lives in the urban band along the Great Lakes, and almost half reside in the Golden Horseshoe. According to Statistics Canada, the province has one of the highest-growing populations in Canada, and the number of households is forecast to grow from 4.2 million in 1991 to 5.6 million by 2016.<sup>40</sup>

End use applications for thermal space heating, space cooling and water heating constitute 52%, 21% and 3.4% (respectively) of residential and 48.6%, 5.3% and 10.1% of commercial energy consumption in Ontario.<sup>41</sup> This total of 720 PJ can be met by GHP (representing 38% of the national total of 1,906 PJ consumed in the same end use applications).<sup>42</sup>

The environmental impact in the residential sector (excluding consumption of electricity) was 14.1 megatonnes of greenhouse gas emissions from space heating and 4.4 MT from water heating in the residential sector, 10.9 MT from space heating, 1.2 MT from water heating, and 0.4 MT from space cooling in the institutional/commercial buildings market.<sup>43</sup>

In Ontario in 2003, there were 85,180 residential housing starts, of which 70,250 were in the top ten Census Metropolitan Areas (CMA) and 14,900 elsewhere in the province.<sup>44</sup>

There are few technical constraints to the adoption of GHP in new buildings, either in the residential or institutional/commercial buildings sector. It is a fully 'dispatchable' distributed resource that can provide energy at any time of day, and performance can be enhanced with thermal storage.<sup>45</sup> The constraints in the retrofit market relate to the need for renovations to accommodate a loop or a distribution system.

The CSA standard stipulates separation distances within loop designs to ensure that one pipe does not 'steal' heat from the collection area of a neighbouring pipe, and it provides guidance to avoid septic tanks, utility line setbacks, and other parameters to ensure proper design and installation in residential or commercial sites.

While a GHP unit can be installed almost anywhere in a building, it is not effective to install a loop under an existing building or under existing infrastructure such as roads. However, it is very practical to install loops prior to construction of buildings or roads. Installation and pumping costs, as well as thermal losses, become significant when a loop is installed more than 250 m from the load, with GHP systems designed to be as close as possible to the load centre.

Due to difficulties in assessing conversion costs for the existing stock of 4.4 million dwellings in Ontario, this paper examines the impact of installing GHP only in new construction, under the 'advanced' scenario. It will assume an average of 75,000 new housing starts a year, of which 80% are located in metropolitan areas (i.e.: 60,000 a year

in metropolitan and 15,000 in ‘rural’ areas).<sup>46</sup> It also assumes a total of 1% of existing stock will convert to GHP over the same period, for a total of 44,000 ‘basic’ units.

Under this scenario, the impact of installing GHP in 10% of metropolitan units and 50% of rural units is illustrated below:

**TABLE 3**

Residential Housing Starts (single-family detached homes only)

	Installations per year	Consumption (000 kWh/year)	Energy savings (000 kWh/year)
Metropolitan	6,000	36,600	100,800
Rural	7,500	45,750	126,000
<b>Existing stock</b>	<b>44,000</b>	<b>550,000</b>	<b>787,600</b>

Note

It is assumed that most metropolitan homes are heated by natural gas but all are cooled through electric air conditioners; it is also assumed that GHP could satisfy 10% of that market. It is assumed that much of the rural homes are not on the gas line and are heated with electricity, oil or propane and that GHP could satisfy 50% of that market. It is also assumed that as homes become more thermally efficient, heating load drops, but air conditioning load continues to climb.

By 2010, 125,000 homes with GHP could be installed in Ontario and their total electrical consumption for space conditioning and water heating would be 1,044,100 MWh. However, these buildings would save the thermal equivalent of 2,148,400 MWh each year (or 7.7 PJ). This projection is for residential space conditioning only, and does not reflect the reduction for domestic hot water or the impact from large-scale institutional/commercial building installations.

Using the same parameters, by 2020 Ontario could have 341,000 residences with GHPs, and their total consumption of electricity for space conditioning load would be 2,361,700 MWh. However, these facilities would save the thermal equivalent of 5,777,200 MWh a year (or 20.8 PJ).

Based on the estimate of 3,064 m<sup>2</sup> of annual consumption of natural gas, the displacement of gas combustion in 2010 would be 383 million cubic metres (m<sup>3</sup>) and more than 1 billion m<sup>3</sup> by 2020.<sup>47</sup>

## 2.1 GROWTH QUICKENS IN NEW MARKETS

There are no empirical models to suggest how retail installed prices would be affected by volume installations, but the installation cost estimates provided by Manitoba Hydro (which has the highest per-capita installation rate in the country) indicates that a hypothetical total of \$20,000 could decline to \$17,000 (15%) with increased

demand. Anecdotal comments from contractors estimate that, if sales volume doubled, cost reductions could be:

- 20% for components (heat pump, transfer fluid, pipe) due to volume purchase;
- 10% for design due to economies of scale and increased speed;
- 25% for installation (horizontal or vertical) due to economies of scale, reduced travel time, improved rates from drillers, etc.

It is possible that average residential system costs could drop by 20% to 25% under an increased volume scenario.

A comprehensive report that analyzed Canadian installations included a sensitivity analysis to assess the impact of rising natural gas and oil prices on the relative cost of GHP, and found that the latter improves its price advantage against conventional space conditioning technologies.<sup>48</sup>

## 3. Mechanisms to encourage GHP

A number of broad-based fiscal, monetary and regulatory measures are required to advance the understanding and acceptance of GHP in Ontario, in both the residential and institutional/commercial building sectors.

Among these, the province must work with federal government officials to develop a method to quantify the energy contribution from GHP in order to enhance its perceived value to the marketplace. It must also request an extension of the eligibility for Class 43.1 accelerated capital cost allowance for GHP installations, and work with federal agencies to facilitate a process under which GHG emission reductions from GHP can be aggregated into a trading pool for credit under the Kyoto Protocol.<sup>49</sup>

The impact of promoting a non-commercial energy source was evident in 1999, when the U.S. Energy Information Administration was estimating total consumption of renewable energies in that country at 3.9 quadrillion (10<sup>15</sup>) British Thermal Units (Btu), mainly from hydro, geothermal electric, wind, solar PV and biomass at electric utilities. An analysis by the Canadian Association for Renewable Energies noted that the data did not include 2.6 quadrillion from GHP, wood stoves, solar water heaters and off-grid wind turbines, solar panels and small hydro facilities, and its intervention prompted EIA to amend its reporting to increase the contribution of renewables by two-thirds.<sup>50</sup> There is



reason to believe that the energy contribution from other renewable heat technologies (specifically GHP) also suffers from significant under-estimation in Canada due to its lack of market quantification.

The province must make every effort, in consultation with the federal government and industry, to define the parameters for GHP (and all renewable heat technologies) to provide a context within renewable energy supply and demand.

It is critical for the province to compile data on the past, present and future installed capacity for the technology in various end use applications, so the economic and environmental impacts can be quantified. In addition, the province must undertake a 'level playing field' assessment of policies pertaining to GHP, similar to the 1992 study by Finance Canada that concluded there was economic discrimination against green heat technologies and which led to the creation of the federal Renewable Energy Deployment Initiative (REDI) in an effort to reduce that discrimination.<sup>51</sup>

GHP is used heavily in Europe for district heating and

cooling systems, in both residential and institutional/commercial buildings. District energy is still a low priority in Canada, but this promising niche should be developed.

A study of the barriers to understanding and acceptance of green heat technologies in general, and GHP in particular, must be undertaken to identify the market niches where this viable technology is most economically and environmentally beneficial.

In addition, any measures that would facilitate the future consideration and adoption of GHP should be considered (e.g. require that new building projects conduct and file a soil conductivity analysis to identify high-efficiency soils for future conversions, pre-install ground loops in residential subdivisions to allow future conversions).

The Ontario Building Code should also be amended to require that new home construction accommodate future installation of GHP, including adequate space for oversized heating ducts, adequate location of new homes to allow future installation of ground loops, and reliance on CSA C448 for the design and installation of all systems.

## 4. Recommendations

To achieve the many benefits that GHP development can generate for the province the Government of Ontario should:

- i. Use its procurement ability to source 20% of the space conditioning and water-heating load in all facilities under its control from GHP by 2010, as part of a green heat procurement program. This level should rise to 50% by 2025 and is aimed at effecting a market transformation in the institutional/commercial building sector. In order to achieve this level, it is expected that almost all new public buildings would incorporate GHP technology, combined with the highest penetration possible for cost-effective retrofits when those buildings need upgrading or refurbishment.
- ii. Enact legislation to require that 20% of space conditioning and water heating in all municipal facilities come from GHP by 2010 and 50% by 2025. Municipal officials would identify the most appropriate facilities assuming that new public buildings would receive priority attention for GHP installation.
- iii. Direct the Ontario Energy Board to require all distributors of space conditioning and water heating fuels to source 10% of their sales within Census Metropolitan Areas and 50% in all other areas from GHP by 2010; 50% and 75% respectively by 2025. Introduction of a 'system benefit charge' on all thermal energy customers could offset any first-cost premium.

- iv. As part of Kyoto commitments to reduce greenhouse gas emissions, collaborate with the federal government to establish a revolving loan system for the financing of ten-year interest-free loans for the installation of GHP, both for interior components and exterior loop, in both residential and institutional/commercial buildings. This measure is estimated at \$1,000 per year (residential) and should be covered by a special 'green fund' that provides a declining level of support and a clear exit strategy.
- v. Enact regulations to highlight GHP as the default space conditioning technology in regions not served by natural gas pipeline to minimize the need to install distribution infrastructure for fossil fuels.

## 5. Conclusions

Every effort should be made to exploit GHP and other renewable heat technologies on both economic and environmental bases.

Without a high-level commitment from regulators that GHP is a preferred option for space conditioning, and without an assured minimal market, the technology will continue to experience market disadvantages when competing with subsidized conventional energy options.

Finally, the provincial government needs to help the GHP industry complete existing plans for training, accreditation and warranty coverage of GHP installations in both residential and institutional/commercial buildings sectors to ensure the sustainable development of this promising renewable energy option.

## GHP Appendix

- A) The need for space conditioning is determined by Heating Degree Days (HDD) and Cooling Degree Days (CDD) at any location, based on a balance point of 18° and insulation levels of the building and occupant factors.
- Toronto (43.7 N latitude) has 3,644 HDD and 346 CDD (Environment Canada 150-year average). Design is –17.1° for heating and 28.8° for cooling.
  - Ottawa (45.3 N) has 4,606 HDD and 242 CDD. Design is –21.4° for heating and 27.6° for cooling.
- B) Four scenarios:
- 1) 185 m<sup>2</sup> (2,000 ft<sup>2</sup>) home in Toronto, medium insulation, 2-storey, full basement, air conditioning, minimal efficiency (2.8 COP) heat pump, standard spacing of horizontal loop configuration, heavy damp soil.
  - 2) same home in Ottawa
  - 3) 9,290 m<sup>2</sup> (100,000 ft<sup>2</sup>) commercial building in Toronto, medium insulation, five-storey, standard windows, daytime occupancy, moderate equipment and lights, minimal efficiency heat pump, vertical boreholes, standard loop configuration, heavy damp soil.
  - 4) same building in Ottawa.

### RETSCREEN OUTPUT:

- 1) Toronto residence:
  - Design heat load of 8.8 kW and 9.9 kW for cooling.
  - GHP requires 255 m pipe in 128 m trench, footprint of 311 m<sup>2</sup>.
  - System consumes 6.9 MWh of electricity for heating and 5.0 MWh for cooling loads, to allow GHP to deliver 15.9 MWh and 13.6 MWh equivalent heating/cooling.
- 2) Ottawa residence:
  - Design heat load is 9.9 kW and 9.4 kW cooling.
  - GHP requires 306 m pipe in 153 m trench, footprint of 373 m<sup>2</sup>.
  - System consumes 8.7 MWh heating and 20.1 MWh cooling, GHP delivers 4.3 MWh and 11.0 MWh.
- 3) Toronto commercial:
  - Design heat load is 212.2 kW and 599.5 kW cooling load.
  - GHP requires 15,341 m borehole, footprint of 4,466 m<sup>2</sup>.
  - System consumes 208.0 MWh heating and 234.3 MWh cooling, while GHP delivers 448.0 MWh and 838.3 MWh.
- 4) Ottawa commercial:
  - Design heat load is 234.9 kW and 574.2 kW cooling load.
  - GHP requires 14,051 m borehole, footprint of 4,086 m<sup>2</sup>.
  - System consumes 232.8 MWh heating and 194.7 MWh cooling, GHP delivers 515.2 MWh and 695.2 MWh.

The following parameters were changed in the RETScreen model:

- Residence: increase insulation levels to high from medium, upgrade loops to vertical boreholes from horizontal, upgrade heat pump COP to 4.0 from 2.8, upgrade loop to very compact from standard, upgrade soil conductivity to light rock from damp heavy.
- Commercial: increase insulation levels to high, COP 4.0 heat pumps, loop bed was very compact, usage of equipment and lights was reduced to light from moderate, and soil conductivity was light rock.

- 1) Advanced Toronto residence:
  - Heat load drops to 5.8 kW and 9.3 kW for cooling.
  - GHP requires 92 m borehole, footprint of 5 m<sup>2</sup>.
  - System consumes 2.5 MWh heating and 8.1 MWh cooling, GHP delivers 3.5 MWh and 15.0 MWh from earth.
- 2) Advanced Ottawa residence:
  - Heat load is 6.6 kW and 8.9 kW for cooling.
  - GHP requires 174 m borehole, footprint of 5 m<sup>2</sup>.
  - System consumes 3.1 MWh for heating and 10.4 MWh for cooling, while GHP delivers 3.1 MWh and 12.3 MWh.
- 3) Advanced Toronto commercial:
  - Heat load is 262.3 kW and 458.0 kW cooling load.
  - GHP requires 7,180.7 m borehole, footprint of 332 m<sup>2</sup>.
  - System consumes 157.0 MWh for heating and 109.0 MWh for cooling, while GHP delivers 461.6 MWh and 570.3 MWh.

- 4) Advanced Ottawa commercial:
- Heat load is 3.5.4 kW and 433.1 kW cooling load.
  - GHP requires 9,470 m borehole, footprint of 439 m<sup>2</sup>.
  - System consumes 185.2 MWh for heating and 88.9 MWh for cooling, while GHP delivers 567.7 MWh and 464.7 MWh.

The RETScreen models indicate that an ‘advanced’ residence that combines higher thermal building efficiency with superior GHP, will reduce space conditioning load compared with an ‘average’ residence by 23% (30 to 23) and by 17% (1,248 to 1,032) in an institutional/commercial building. This improvement in both the demand and the supply sides means that a GHP system would consume 50% less electricity (12 to 6) to

deliver full space conditioning in a home and 38% less (435 to 270) in an institutional and commercial building.

The same residence was modeled in two northern centres for comparison:

- Thunder Bay (48.4 N): heating load was 11.7 kW (27.4 MWh) and 9.3 kW cooling (9.7 MWh), requiring 387 m of loop pipe in 193 m trench and a footprint of 472 m<sup>2</sup>. System consumes 11.7 MWh to deliver 27.4 MWh from GHP, and consumes 4.0 MWh to deliver 9.7 MWh from GHP cooling.
- Big Trout Lake (53.8 N): heating load was 13.2 kW (35.1 MWh) and 8.2 kW cooling (5.7 MWh), requiring 463 m of pipe in 231 m trench and footprint of 564 m<sup>2</sup>. System consumes 14.8 MWh to deliver 35.1 MWh GHP heating, and consumes 2.9 MWh to deliver 5.7 MWh in GHP cooling.

### GEOTHERMAL ENERGY IS HOT IN MANITOBA

Manitoba is leading Canada in total installations of GHPs, representing 30 percent of total new Canadian installations last year. Geothermal heat pumps are one of the most energy efficient, environmentally-responsible home heating and cooling systems available. Heat pump technology works by moving heat out of or back into the earth. Geothermal units are connected to the earth through pipe buried under your lawn or landscaped area.

Manitoba Hydro currently offers home-owners a loan of up to \$15,000 to install a geothermal heat pump when building a new home or replacing an old heating system. Manitoba Hydro, working closely with the International Ground Source Heat Pump Association, has sponsored installer certification courses in order to build the market infrastructure in Manitoba. In fact, the number of IGSHPA certified installers in Manitoba has increased by 130% over the last year.

One of the initiatives currently being explored by the Province of Manitoba, the City of Winnipeg and Manitoba Hydro is the potential for a 100 percent geothermal new home development in Winnipeg – Waverley West; which if implemented would be the largest geothermal housing development in Canada.

The energy savings achieved by installing a geothermal heat pump system are considerable. Manitoba Hydro has found that geothermal heat pumps can reduce annual heating bills by \$400 to \$800 compared to natural gas; by \$600 compared to electric heating; and by \$700 to \$1,800 compared to heating oil and propane based on rates as of May 1, 2004.

According to Manitoba Hydro, each geothermal home reduces carbon dioxide emissions by 9 tonnes and each commercial unit by 34 tonnes. Each 1,000 residential installations results in \$15 million in construction-related activity and over 150 jobs



### TORONTO OFFICE TOWERS COOLED BY LAKE ONTARIO

More than 100 office towers in downtown Toronto are using an alternative source of air conditioning – cold water from Lake Ontario.

Enwave District Heating is bringing “deep water cooling” to Toronto, making it the largest lake source cooling system in the world. The deep lake cooling project takes cold water from Lake Ontario and draws it into a downtown pumping station. From there, through a series of heat transfers, the cold lake water is used instead of electricity to air condition buildings along the Enwave network.

Three pipes extend five kilometres out into Lake Ontario, reaching a depth of 83 metres below the lake surface. The pipes draw near-freezing water to cool downtown office buildings. The water is then

transferred to the city’s water treatment system and becomes safe drinking water.

The Air Canada Centre, the Metro Convention Centre, the Steam Whistle Brewing Company, the Royal Bank Tower and the offices at 1 University Ave. are just some of the buildings using deep lake water-cooling.

This cooling process requires less energy and reduces electricity use by up to 75 percent less than conventional cooling. According to Enwave, emissions from coal-fired electricity will be reduced by more than 40,000 tonnes. The lake water-cooling system eliminates the need for conventional, on-site mechanical air conditioners that consume electricity and rely on CFC refrigerants. The project is expected to save 30 million kWh a year and free 35 megawatts of capacity from the provincial grid.



## Vancouver complex is hot stuff

Geothermal energy heats and cools thousands of buildings worldwide, including a large apartment and business complex in the heart of Vancouver, B.C.

The mixed-use, four-storey building doesn't use fossil fuels for heating or cooling. Geothermal energy provides heat and hot water for the complex, which includes a combination of retail stores, offices and apartments.

During the complex's construction, builders drilled 46 holes 100 metres into the ground. Inside the holes run a series of closed-loop plastic pipes filled with water. The water flows through the pipes, absorbing heat from the earth. The warm liquid is piped to a heat pump in the building. The pump releases the heat, which is circulated as warm air by electric fans. In the summer, the process is reversed, with the system pulling heat out of the building and distributing it back into the earth.

Initial costs to install the geothermal energy system were higher, but it paid for itself after just three years. The system is highly efficient. For every watt of electricity used, the system provides three to four watts of heating or cooling power. That reduces operating costs by 50 to 75 percent over conventional systems. Other cost savings come from maintenance of the simple system, which has fewer mechanical components.



## GEOTHERMAL CHAPTER NOTES

- 1 See Union of the Electricity Industry and International Union for Electricity Applications. (2004). *Electricity for more Efficiency: Electric Technologies & their Energy Savings Potential*. Brussels: EURELECTRIC. Available at [www.eurelectric.org/PublicDoc.asp?ID=27573](http://www.eurelectric.org/PublicDoc.asp?ID=27573) and also Caneta Research. (1999). *Global Warming Impacts of Ground-Source Heat Pumps Compared to other Heating Cooling Systems*. Ottawa: NRCan Renewable & Electrical Energy Division. Available at [www.geo-exchange.ca/en/newsroom\\_reports.html](http://www.geo-exchange.ca/en/newsroom_reports.html)
- 2 This chapter will not address air-source heat pumps (which extract latent heat from ambient air and offer limited capacity when outside air temperatures are below freezing), nor internal loop heat pumps (which employ the same compressor technology as GHPGHPGHP but rely on roof-top chillers or boiling towers as their heat source / heat sink), nor direct-use geothermal (such as hot springs in Banff or Iceland), nor the generation of electricity from deep geothermal boreholes (such as the South Meagher site in B.C.). The last two technologies have no available resource in Ontario.
- 3 Illustrations for five configurations are available at <http://www.canren.gc.ca/school/index.asp?CaId=180&PgId=1001>
- 4 A general industry guideline is that a body of water with 2,000-m<sup>2</sup> surface area and a depth of 3 m hold sufficient thermal heat for an average-sized home.
- 5 The minimum COP allowed in Canada is 2.8, with most models claiming a COP of 3.5 to 4.0 and, in some hybrid applications, reaching a non-certified COP of 7.0. Performance is rated under CSA 13256 (approved in 1998) based on an ISO standard, while models rated under the earlier CSA standard C446 or the U.S. ARI equivalents are accepted in Ontario
- 6 Each building (residential or institutional and commercial) must calculate its heat loss prior to determining its conditioning load, and the seven-step soil classification can have a 4:1 differential on the amount of loop required for the same building envelope due to soil conductivity (which would increase the cost of loop installation accordingly).
- 7 See Earth Energy Society of Canada (2001) at <http://www.earthenergy.ca/saving.html>
- 8 See Office of Energy Efficiency. (2000). *Home Heating & Cooling: A Consumer's Guide*. Ottawa: NRCan. Available at: <http://oee.nrcan.gc.ca/publications/infosource/pub/home/M91-2-41-2002E.pdf>
- 9 See Manitoba Hydro's price comparisons [http://www.hydro.mb.ca/saving\\_with\\_ps/home\\_heating\\_comparisons.pdf](http://www.hydro.mb.ca/saving_with_ps/home_heating_comparisons.pdf)
- 10 Based on retail power rates of 5.16¢/kWh and a seasonal COP of 2.5.
- 11 Marbek Resource Consultants (1999). *Ground Source Heat Pump Market Development Strategy*. Ottawa: NRCan.
- 12 See Office of Energy Efficiency. (2000) op. cit. note 8.
- 13 Calculation details available from Earth Energy Society of Canada ([www.EarthEnergy.ca](http://www.EarthEnergy.ca))

- 14 See page A50 of budget paper titled “The Economy” in Manitoba Finance. (2004). The 2004 Manitoba Budget Papers. Available at [www.gov.mb.ca/finance/budget04/papers](http://www.gov.mb.ca/finance/budget04/papers)
- 15 See Information Survival Kit for the Prospective Geothermal Heat Pump Owner, published by Geo-Heat Center, April 2004, viewable at <http://geoheat.oit.edu/ghp/faq/faq02.htm> Fuel costs are quoted at US\$0.07/kWh for electricity, \$1.05/gallon for fuel oil, \$1.20/gallon for propane, \$0.60/therm for natural gas, with a house in a “moderately cold climate.” Savings do not include DHW heating and space cooling.
- 16 IEA. (2002). *Closed Loop Ground-Coupled Heat Pumps: Informative Fact Sheet*. Available at: <http://www.heatpumpcentre.org/publ/HPCOrder/ViewDocument.aspx?RapportId=14>
- 17 See IEA Heat Pump Centre Newsletter (volume 22, number 2, 2004). Available at: [http://www.heatpumpcentre.org/Home/Newsletter\\_N22.02.pdf](http://www.heatpumpcentre.org/Home/Newsletter_N22.02.pdf)
- 18 The publication, Environmental Protection Agency. (1993). *Space Conditioning: The Next Frontier*, analyzed several space conditioning technologies (GHP technologies, air-source technologies, oil, and natural gas systems) in six regions of the U.S. and identified GHP as the top choice for heating and cooling in all locations, with the lowest annual operating costs and lowest annualized costs in all locations (except Portland), and best option for GHG mitigation.
- 19 ‘Low temperature geothermal’ can refer to either GHP or direct use geothermal, but not to generating capacity.
- 20 Since June 2002, the Canadian Association for Renewable Energies has tried to obtain data from the federal government on renewable energy in Canada; see <http://renewables.ca/atip.html>. Access to Information requests indicate that no data are available at the federal level.
- 21 Select Committee on Alternative Fuel Sources, Legislative Assembly of Ontario, Final Report, 3<sup>rd</sup> Session, 37<sup>th</sup> Parliament, page 8. There are no data provided on GHP capacity or forecasts.
- 22 Between 1995 and 2003, there were at least four separate attempts to compile data from manufacturers, including the use of double-blind surveys. The refusal to provide data is attributed to competitive issues between the small numbers of manufacturers operating in Canada.
- 23 The program involved a \$2,000 rebate for homes that installed a certified GHP unit from a registered contractor trained by the CEEA; the rebate was not provided to homeowners who could access natural gas service and was intended to stem the customer base that was converting to natural gas for heating while leaving the utility with plug load. Termination of the rebate was perceived by many consumers as a failure of the technology, and sales in Ontario declined for a number of years.
- 24 RETScreen was developed in 1998 by NRCAN’s CANMET Energy Diversification Research Laboratory to evaluate energy performance, cost and financial viability of implementing renewable energy technologies. As of March 2004, NRCAN says there are 41,500 users in 196 countries. See [www.RETSscreen.net](http://www.RETSscreen.net)
- 25 Energy required to heat and cool the facility (excluding water heating) over a one-year period.
- 26 Electricity required for one year to operate the GHP system in heating and cooling modes, to provide the same level of heating and cooling.
- 27 Total electricity for heating and cooling over one year, averaged between Toronto and Ottawa.
- 28 Comprehensive Energy Use Database, 2002, published by NRCAN, viewable at [http://oe.nrcan.gc.ca/neud/dpa/comprehensive\\_tables/index.cfm?text=N&printview=N](http://oe.nrcan.gc.ca/neud/dpa/comprehensive_tables/index.cfm?text=N&printview=N)
- 29 See GHP Appendix: 12,500 MWh versus 30,300 MWh.
- 30 See GHP Appendix: 6,100 MWh versus 22,900 MWh.
- 31 See GHP Appendix: 6,100 MWh versus 30,300 MWh.
- 32 Using estimates based on Enbridge Gas Distribution billing.
- 33 EPA (1993) op.cit. note 19 Marbek (1999) op.cit note 11.
- 34 Marbek (1999) op.cit. note 11.
- 35 Based on a COP of 4.0.
- 36 See <http://IMBY.org>; In My Back Yard.
- 37 Estimate compiled by Earth Energy Society of Canada.
- 38 Ibid.
- 39 Martin Cloutier, Manitoba Hydro (September 2004), personal communication.
- 40 Ontario Ministry of Finance, Population Projections.
- 41 Comprehensive Energy Use Database (2002) NRCAN, [http://oe.nrcan.gc.ca/neud/dpa/comprehensive\\_tables/index.cfm?text=N&printview=N](http://oe.nrcan.gc.ca/neud/dpa/comprehensive_tables/index.cfm?text=N&printview=N)
- 42 Comprehensive Energy Use Database (2002) NRCAN, [http://oe.nrcan.gc.ca/neud/dpa/comprehensive\\_tables/index.cfm?text=N&printview=N](http://oe.nrcan.gc.ca/neud/dpa/comprehensive_tables/index.cfm?text=N&printview=N)
- 43 Ibid.
- 44 See Housing Market Indicators, Ontario, 1990–2002 in Canadian Mortgage and Housing Corporation. (2003). Canadian Housing Observer. Ottawa: CMHC. Available at [www.cmhc-schl.gc.ca/en/cahoob/index.cfm](http://www.cmhc-schl.gc.ca/en/cahoob/index.cfm)
- 45 Energy is provided on demand; it is not conditional on external storage or reliant on weather patterns.
- 46 CMHC (2003) op.cit note 44.
- 47 Enbridge op. cit. note 32.
- 48 Marbek (1999) op. cit. note 11. The report analyzed 135 scenarios in 12 building segments (elementary school, high school, seniors complex, high-tech facility, curling rink, hockey arena, mid-size hotel, motel, suburban office, high-rise condominium, retail strip mall, residential subdivision) at sites in Toronto, Montreal, Winnipeg, Vancouver, Moncton and Kamloops.
- 49 A process to aggregate GHG credits from residential GHP systems was developed by the Earth Energy Society of Canada in 2002.
- 50 For details see Environmental News Network. (July 13, 1999). DOE renewable energy reports questioned. Available online at [www.enn.com/news/enn-stories/1999/07/071399/renew\\_4310.asp](http://www.enn.com/news/enn-stories/1999/07/071399/renew_4310.asp)
- 51 For details about REDI see <http://www.canren.gc.ca/programs/>



## Summary

**SOLAR ENERGY CAN BE** used in Ontario to generate pollution-free electricity and heat for residential, institutional, industrial, and commercial applications.

The most promising solar technologies in the short term are those that capture the sun's rays to heat indoor spaces or water, thereby replacing fossil fuels or nuclear energy that would have been used in these applications. These relatively simple and low-maintenance technologies can provide elegant, clean solutions to some of our energy needs.

Solar energy currently provides 8% of the average Canadian home's heating requirements (in the form of sunlight entering through windows). This proportion of 'solar thermal' energy (converting sunlight into heat) could be easily increased to 22% with minor changes in community planning, building design, and higher standards.

Solar thermal energy can also provide 40–50% of residential hot water heating and 15% of commercial hot water heating requirements at a cost below the current price of electrically heating water (at the equivalent of 8.4 cents per kilowatt hour), while 39% of pools can be heated using solar thermal panels. Solar walls in new construction can replace other energy sources for space heating at the equivalent of 2 cents per kWh.

Achieving the province's solar thermal potential will require a mix of regulatory changes (e.g. building codes, zoning by-laws), marketing support programs to raise public awareness and inform builders on solar thermal options, and tax changes to actively promote solar thermal technologies.

Solar photovoltaic (PV) systems, which convert sunlight into electricity, are currently less cost-competitive

but have the advantage of generating clean, reliable power on site at the time of peak usage. It also has no moving parts so requires little maintenance and the fuel is free.

By implementing the policy measures proposed in this chapter, Ontario could capture one-half of the technical potential for solar thermal and photovoltaic technologies, providing as much energy in 2025 as coal did in 1999.

Japan and Germany are two countries with relatively modest solar resources but have nevertheless quickly become world leaders in solar photovoltaic (PV) technology.

The experience of these leaders clearly illustrate that strong solar markets can be quickly established if supportive policy measures that focus on the use of gradually declining subsidies, strong government R&D, and active market penetration are implemented.

Germany has become a world leader in solar PV through the enactment of its renewable energy mechanisms (REMs) law that guarantees stable payment for each kWh of PV-generated electricity, and grid access for PV owners.

Southern Ontario has some of the best solar potential in Canada and the province can support a significant expansion of PV and solar thermal technologies by implementing REMs and other key supporting initiatives that address existing financial, technical, and educational barriers.

The solar industry worldwide has been growing at double-digit rates, and Ontario is in a unique position of benefiting from this well-established trend. By supporting its burgeoning solar industry, Ontario can obtain reliable energy (without fuel costs), a cleaner environment, and strong job creation.

This chapter identifies the potential applications for solar technology in Ontario; it also reviews recent developments and policies in other countries, and



proposes a series of policy initiatives that would greatly increase the contribution of solar energy in Ontario over the next 15 years.

## 1. Background on solar energy

While there have been assessments on the potential of individual solar technologies carried out in the past (mainly in the 1980s and early 1990s), there has not been a comprehensive assessment of solar potential in Canada or its provinces.<sup>1</sup> In part this is due to a flawed, but widely held, assumption that solar has low potential for making a significant impact on the energy needs of Canada. In addition, the fact that the three main solar technologies (photovoltaic, thermal, and passive) include a variety of niche markets makes an overall assessment difficult.

Solar energy is almost exclusively an on-site generator of energy. As such, its implementation represents a major paradigm shift away from central power plant generation.

While solar energy is often considered an option for the future, right now 8% of the average Canadian home's heating requirements are supplied by the solar energy that flows naturally into homes through south facing windows. By proper community planning and only minor alterations in new house design and construction this share could easily be increased.

While there are many widespread misunderstandings surrounding solar energy, one of the most prevalent is that Ontario does not receive sufficient sunlight to provide a practical power source. In reality, Ontario has a greater solar resource than many of the current solar leaders (Japan and Germany). Toronto, in fact, has a better summer solar resource than the city of Miami, Florida.

Solar energy can be used to generate electricity using solar photovoltaic (PV) systems and can also be harnessed for thermal applications (e.g. space and water heating, which displaces electricity and/or fossil fuels currently used for those purposes).

PV systems are currently widely used to provide power in remote areas (e.g. for telecommunications systems, navigational signals, off-grid applications), and their use for grid-connected electricity generation is growing rapidly in a number of jurisdictions such as: Germany, Japan, and the state of California. As the price of PV systems drop, the potential to meet Ontario's electricity needs will be significant.

Solar thermal applications can be used to satisfy space conditioning and hot water needs. For example, building

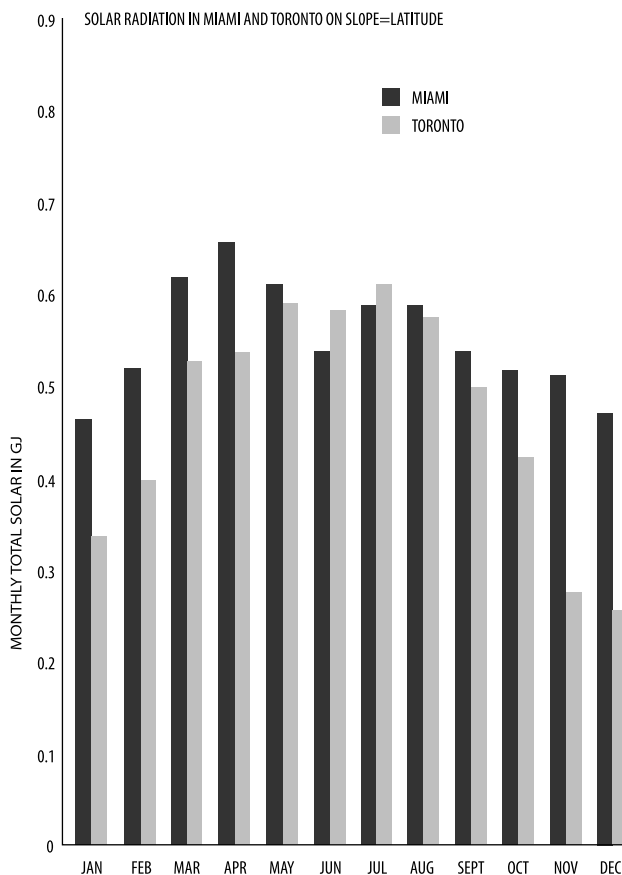

FIGURE 1 Solar Radiation in Miami and Toronto<sup>2</sup>

owners in Ontario can reduce their hot water energy bills by 40–50%, by installing a solar water heater.<sup>3</sup> Solar hot water systems can be installed in almost every kind of building, from a single suburban home to a condominium or apartment building. Plus, if the cost of a solar hot water system (SHW) is calculated over the life expectancy of the system (using the same methods that utilities employ to estimate the cost of the electricity they supply to consumers), then solar thermal is one of the cheapest ways to generate heat available today.

Commercial and industrial buildings can use cladding designed to collect the sun's heat for heating and cooling purposes with virtually no additional material costs. Buildings can also be designed with day lighting principles (thereby significantly reducing the need for artificial illumination and its associated electricity use). Roofing shingles and glass can be made of photovoltaic (PV) materials that generate electricity. Many of these solar systems can be used instead of existing construction materials and can contribute significantly to the entire lifetime energy needs of a building.

However, as a result of a pervasive and widespread focus on electricity generation, solar thermal systems are

often not considered when energy issues are discussed. Furthermore, solar thermal applications are also not generally addressed under discussions of energy conservation (in such cases they are often excluded because they are widely considered as a “generator of energy”).

Although often overlooked, solar energy can be an important local energy solution in Ontario that can supply clean and reliable electricity and heat – without any fuel costs. Solar energy has an important role in reducing our dependency on polluting fossil fuels and unreliable nuclear energy.

### 1.1 WORLDWIDE SOLAR DEVELOPMENT

The world market for photovoltaic (PV) systems has been growing at 30% annually for the past five years.<sup>4</sup>

In 2003, production of PV cells and modules reached the highest-ever level at 744 MW, which represents a 32.4% increase over the 2002 production figure of 562 MW.<sup>5</sup>

In Japan, PV cell and module production increased 45% during 2003, and in Europe there was a 43% increase in PV production.<sup>6</sup>

The bulk of the 2003 PV production was used for grid-connected installations in the leading solar markets of Japan (200 MW) and Germany (120 MW).

Japan was a minor PV player in the early 1990s but through a combination of supportive policies and active public education, the country rose to become the world’s largest producer and user in less than a decade. By relying on renewable energy mechanisms, low-interest loans, comprehensive education programs, rebates for grid-connected residential systems, and government procurement, Japan has now three times as much PV capacity as the entire United States.<sup>7</sup>

Germany’s impressive success in wind power has also been replicated in its PV sector. Second only to Japan’s PV market, Germany’s PV installations have grown at an average annual rate of nearly 49% since 1992 and reached 417 MW of installed capacity, mostly on-grid, at the end of 2003.<sup>8</sup> Germany’s PV success is the result of two key policies: a) feed-in laws that guarantee a fixed price for any power fed into the grid from a renewable source (referred here as renewable energy mechanisms), and b) a government initiative that provides low-interest loans to purchase PV systems (the ‘100,000 solar roofs programme’).<sup>9</sup>

Japan and Germany are two countries that have modest solar resources but have nevertheless become world leaders in PV technology. Their success is based

on the fact that they both share a long-term commitment to advancing renewable energy and have implemented effective and consistent policies focused on the use of gradually declining subsidies, strong government R&D, and active market penetration.

Canada is lagging significantly behind other industrialized nations in the deployment of PV. Canada has an installed PV capacity of 0.28 watts per capita, which is only 28% of the IEA average (1.0 watt per capita) and is considerably behind the world leaders of Japan (3.6 watts per capita) and Germany (2.4 watts per capita).<sup>10</sup> Figure 2 shows the 2001 installed PV capacity in a number of countries.

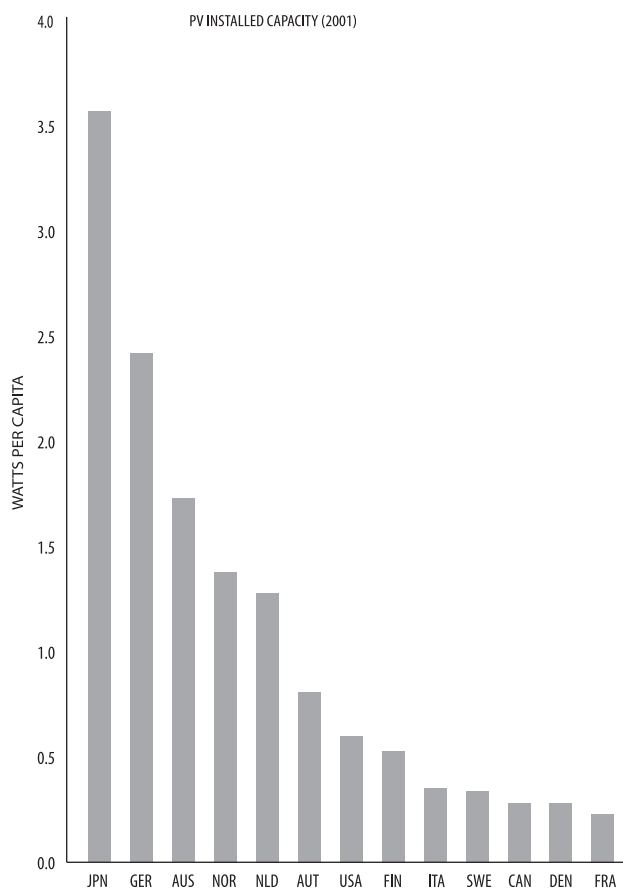

FIGURE 2 PV installed capacity (2001)

At the end of 2001 a total of 100 million square metres (m<sup>2</sup>) of solar thermal collectors were installed in 26 IEA member countries, with about 71% of collectors in use for hot water and space heating, 28% for heating swimming pools, and 2% for drying agricultural products and space heating.<sup>11</sup>

Germany is the leading solar thermal market in Europe and in 2003 installed about 80,000 systems (720,000 m<sup>2</sup> of glazed collectors).<sup>12</sup> These systems are

currently promoted by the German government through a market incentive program that provides a subsidy of \$180 per m<sup>2</sup> of collector surface area. However, the German government and industry are collaborating to replace this program with a new law that would provide a payment for every equivalent kWh of heat generated by renewable energies (this system is inspired by the REM currently in place for PV electricity generation).<sup>13</sup>

## 1.2 SOLAR ENERGY IS A RAPIDLY GROWING BUSINESS

The market for solar worldwide is expanding rapidly with impressive growth rates that are comparable to those of the personal computer and cell phone industries in the boom markets of the 1980–90s.<sup>14</sup> PV markets globally are now worth US \$3.5 billion a year and are expected to grow to US \$28 billion by 2012.

In Canada, solar markets are in a very early development stage and the current national PV market is more similar to those of low-income nations where the majority of installations (>95%) are for off-grid applications. The trend within industrialized nations is for an increasing proportion of PV sales (currently >80%) for grid-connected applications supported by market-enhancing government programs and proactive policies.

Natural Resources Canada (NRCan) has conducted an annual survey of the PV market in Canada since 1996, which shows annual double-digit growth. As the market is exceedingly small and diverse it is unlikely that the survey, with the limited resources dedicated to it, captures all sales in Canada. The need for accurate data will become more acute as the PV industry begins to expand rapidly into the grid-connected market. Unfortunately, the NRCan survey does not provide provincial breakdowns

of sales. The Canadian Solar Industry Association (CanSIA) estimates Ontario's current installed capacity and annual sales as shown in the Table below.

**TABLE 1**

Estimated grid connected PV sales in Ontario in peak kW (KWp)

		Installed (2001)	Sales (2003)
Residential	Existing homes	50	20
	BIPV	5	8
Commercial	Rooftop	50	20
	BIPV	n/a	20
<b>Total</b>		<b>105</b>	<b>68</b>
<b>Electricity</b>	<b>KWh</b>	<b>105,000</b>	

Note.

The maximum possible output of a PV system operating under standard conditions is defined as its peak output, and is measured in watts or kilowatts and can be expressed as Wp (watt, peak) or kWp. BIPV = Building Integrated Photovoltaic.

PV generation calculation assumes that during peak sun hours a location can receive 1000 W/m<sup>2</sup> per hour and that the average in Canada is about 4 hours of peak sun per day (i.e. 4000 Wh/m<sup>2</sup>/day); therefore, in a year (365 days) = 1460 hrs of peak sun (1,460,000 Wh/m<sup>2</sup>/year). Thus, 1 watt of PV will produce about 1,460 watt-hours of energy. However, there are system and operational losses (e.g. inverters, batteries, and line loss), which will reduce the total that can be delivered to the grid to about 80% (hence we assume 1,168 watt-hours); therefore, we can express the final calculation as 1 watt of PV = 1000 watt hours (or 1 kWh) per year.

## 1.3 TECHNICAL CONSIDERATIONS

Solar technologies can be used to generate electricity, and also to satisfy residential and commercial heating, cooling, and illumination needs which helps to displace electricity and fossil fuels currently used for those purposes.

### PHOTOVOLTAIC

Electricity can be obtained by the use of photovoltaic (PV) systems, which rely on sunlight (photons) to generate an electric current.<sup>15</sup> This chapter considers four applications for grid-connected PV systems in Ontario: residential rooftop (existing homes); residential roof Building Integrated PV (BIPV) for new homes; commercial/institutional rooftop PV; and façade BIPV for new commercial buildings.

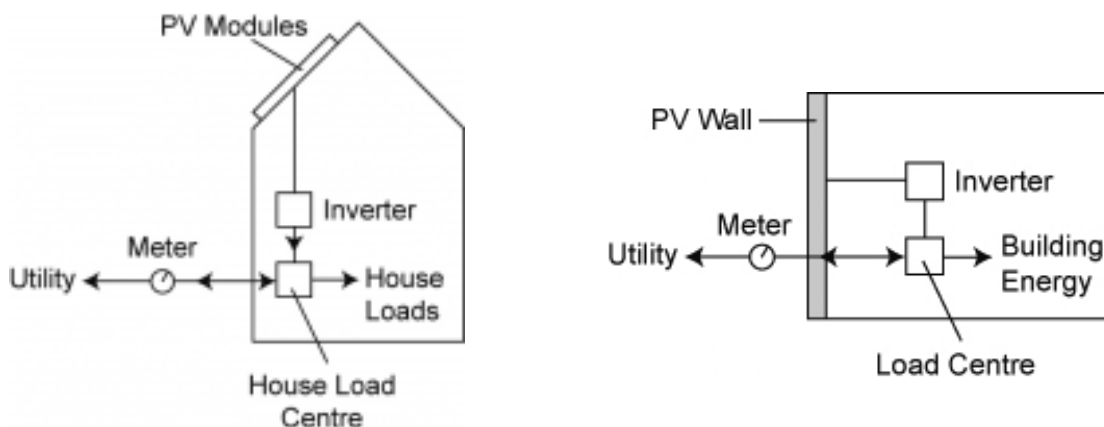

FIGURE 3 Rooftop PV and facade building integrated PV (BIPV)

### SOLAR AIR VENTILATION

Ontario is home to a company that is the world leader in manufacturing solar air ventilation (SAV) systems. However, most of the company's sales are international, and Ontario lags behind in the use of this technology when compared to other provinces and countries. SAV is a simple technology that can have great positive impacts on the space heating needs of commercial and industrial buildings. In existing buildings it can be retrofitted over existing walls, while in new construction SAV systems can actually take the place of a conventional wall. In terms of electricity, Solarwall (the trade name for solar air ventilation systems) can save about 556 kWh per square meter (m<sup>2</sup>) per year in Ontario. In terms of peak capacity, each m<sup>2</sup> of Solarwall panels can generate the equivalent of over 500 watts or 0.5 kW of thermal energy when the sun is shining.

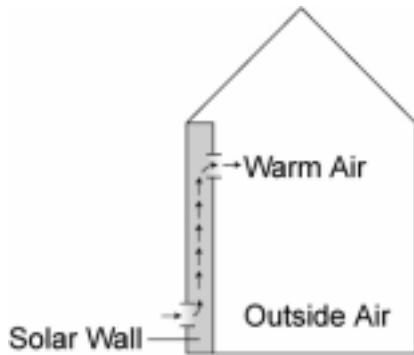

FIGURE 4 Solar air ventilation system (SAV)

Solar air ventilation systems are a competitive energy source now – providing clean energy at the equivalent of less than two cents per kWh if amortized over six years in new construction (where it replaces a metal wall). Installation costs are similar to the cost of a brick wall in new construction and thus the net cost for the energy it produces is zero.

### SOLAR WATER HEATING

Solar hot water collectors (like PV modules) have a capacity factor of 10–15% due to the fact that the sun doesn't shine all the time; i.e., a 1.5 kWp (1,500 Wp) solar thermal collector will deliver on average about 150 to 225 W of equivalent thermal power.

On an energy basis, the cost of solar thermal energy ranges between four to seven cents per kWh over the system's 20-year life expectancy. Solar hot water systems have a 20–25 year life expectancy during which the system does not require much attention (i.e. limited repairs and maintenance).<sup>16</sup>

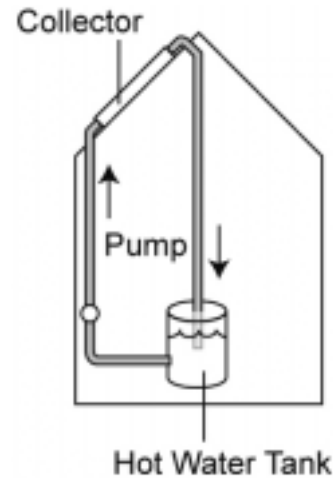

FIGURE 5 Solar domestic hot water (SDHW) system

Policy makers often ignore the issue of swimming pool heating as they consider it to be an insignificant market. However, an average heated outdoor residential swimming pool in Ontario will consume as much energy (40–50 GJ) over the summer swimming season as a typical house uses for space heating during an entire year. In Ontario there are an estimated 130,000 pools that are heated using natural gas and electricity – consuming 4.8 PJ (or the equivalent of 1,330 GWh) of non-renewable energy per year (2001).<sup>17</sup>

Solar water heating is relatively simple to integrate into a swimming pool's water filtering and circulation system. Pool water is pumped through the solar collectors using the pool's existing pump on sunny days while a bypass valve, operated manually or with a temperature-controlled solenoid valve, will bypass the solar collectors during the night or during cloudy weather.

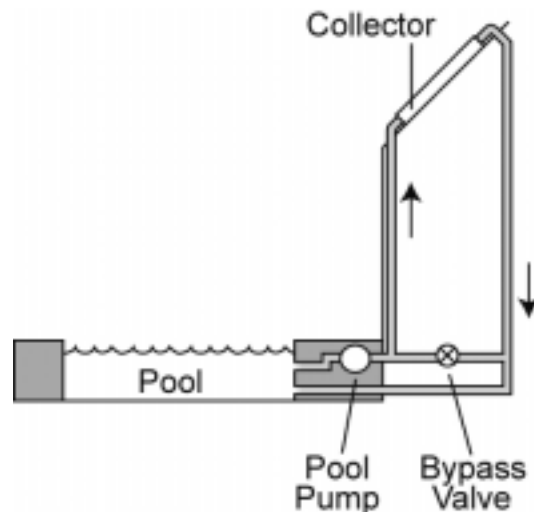

FIGURE 6 Solar pool heating system

### ON SITE SOLAR GENERATION: NET ZERO ENERGY HOME

Solar technologies are most effective when installed on the building in which the energy is to be used, as this approach eliminates land-use competition issues, avoids the construction of stand-alone support structures and reduces problems of energy delivery (e.g. delivery costs and transmission losses). Furthermore, solar energy is unique and readily available as an on-site source of energy. As such, one of its greatest impacts will be at the home level, as various solar technologies can be combined to significantly reduce the need for outside energy. While an average house in Ontario used 116 GJ of outside energy annually in 2001 – this figure could be reduced to less than 50 GJ when solar energy usage is maximized and integrated with energy efficiency measures.

### PASSIVE SOLAR

Passive solar is mainly a design concept rather than a specific product. The contribution of passive solar design to space heating needs is a matter of arranging and using the various components of a building to gain and utilize net solar heat and light to achieve optimal effect. The energy balance of solar gains and losses through the building components provides the “net” energy. Properly designed homes can increase the sun’s energy contribution for space heating and lighting loads, as well as reducing energy losses and cooling needs.

### 1.4 BENEFITS OF SOLAR ENERGY

The use of solar energy for electricity generation and for thermal applications provides unique opportunities to minimize dependency on imported fossil fuels and nuclear energy.

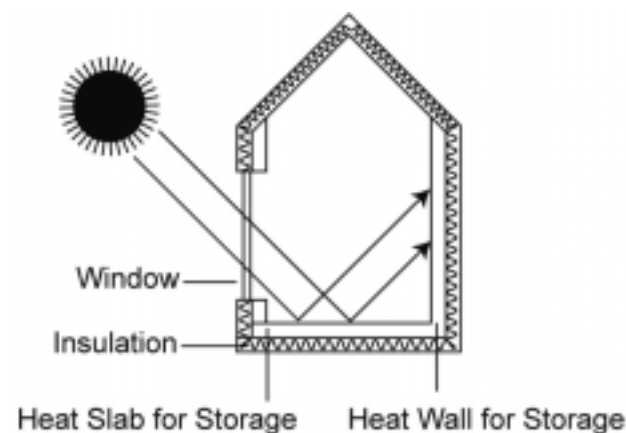

FIGURE 7 Passive solar design

Solar technologies such as PV are highly modular (i.e. can be easily adapted to meet changing energy needs) and can be used in grid-connected and stand-alone applications. PV systems can also be combined with other renewable energy systems (e.g. wind turbines, small hydro) to implement hybrid electricity systems that are increasingly used in difficult-to-access areas to displace cumbersome diesel generation.<sup>18</sup>

Solar technologies provide clean and reliable energy services without fuel costs. They can be used in all types of buildings and for commercial purposes (e.g. car washes, laundry facilities, and recreation facilities such as swimming pools and water parks).

Solar thermal technologies can help reduce the total energy bill of Ontarians and reduce their greenhouse gas emissions. For example, water heating represents about 20% of the average Canadian home total energy bill and results in an average of two tonnes of CO<sub>2</sub> emissions per water heater.<sup>19</sup> Solar water heaters can reduce the electricity or fossil fuels usually used for water heating by 40–50%. New solar systems can provide water heating at the equivalent of about five cents per kWh (competitive with electricity and natural gas prices).<sup>20</sup>

The development and implementation of solar technologies can also result in employment gains and new export products (as shown by the activities of key innovative Ontario-based solar companies).

### 1.5 EMPLOYMENT

Information on the job potential of the various solar technologies in Ontario is sketchy, at best, and there has been little empirical analysis of the current or potential size of the solar industry.

Employment creation analysis is further complicated by the diverse nature of the solar industries.

Passive solar is the largest single segment of the solar technologies in regard to actual energy generation; however, it is rarely acknowledged as an energy source and the jobs in this field tend to be included under general construction trades and window manufacturers. Therefore, the employment potential of solar passive options is not discussed in detail in this chapter.

Currently, the majority of solar manufacturing jobs in Canada are for products exported outside of Canada. Canada’s four main solar manufacturers Conserval (solar air ventilation), Xantrex (inverters for PV), Thermo Dynamics (solar hot water collectors, and most recently

– Spherical Solar (PV modules) are focused on export markets with about 50–75% of their products being exported.<sup>21</sup> These firms are leaders in the solar industry internationally; however, the main reason for their high export ratios is because of the lack of a Canadian market for their products.

Employment in the solar sector tends to fall into manufacturing, installation, operations and maintenance.<sup>22</sup>

There are a wide variety of other indirect jobs associated with solar including the manufacturing of balance of system components, which for the technologies considered in this chapter include:

- PV system (batteries, inverters, mounting hardware)
- Solar hot water (pumps, plumbing, controls, mounting hardware, heat exchangers, water tanks)
- Solar pool heating (plumbing)
- Solar air ventilation (fabrication of metal, including ductwork and ventilation equipment)
- General: glass manufacturing, metal framing, control electronics, software.

As the solar installed capacity in Canada is still small, the number of jobs in the solar operations and maintenance sector is currently insignificant. As solar systems are installed on buildings and there is no technical operator (such as required by a wind farm or a hydroelectric facility), there is a need for firms to provide periodic maintenance. As deployment of solar technologies increase and the installed base expands, this sector will begin to contribute a significant number of jobs.

Currently, there is a lack of employment statistics on the solar industry in Canada and, unlike other OECD nations, there is no ongoing annual survey that tracks employment trends.

Nevertheless, a number of employment estimates exist and indicate that the Canadian PV industry currently provides between 600–1,000 jobs, and that the solar thermal industry supports about 180 jobs.<sup>23</sup>

At the moment the solar industry in Canada is very underdeveloped and few economies of scale are in place. Most manufacturing plants are operating at well under their capacities (25–33% is a figure often quoted), and installers are not working continually in implementing solar systems.<sup>24</sup> Therefore, the estimates provided here of jobs per installation in the solar industry might be higher than the actual jobs achieved if a much greater level of deployment was to develop.

#### EMPLOYMENT POTENTIAL OF PHOTOVOLTAIC (PV)

The PV sector is expected to contribute to the creation of over two million jobs worldwide in 2020, mainly in small and medium sized firms.<sup>25</sup> However, analysis of the pertinent literature reveals a lack of consensus in methodologies and on job creation per MW of PV installed (i.e. a range of 13–185 jobs per MW installed).<sup>26</sup>

Due to the wide range of available estimates this chapter uses a figure of 35 jobs per MW of PV installed annually.

#### EMPLOYMENT POTENTIAL OF SOLAR WATER HEATING

CanSIA estimates that six jobs can be created per 1,000 m<sup>2</sup> of solar hot water collectors installed not including maintenance personnel.

Canadian data for solar pool heating is not readily available, however, CanSIA estimates that for each 1,000 systems installed annually, 12 installation jobs and 1.6 maintenance jobs are created (these figures do not include any employment creation related to manufacturing).

#### EMPLOYMENT POTENTIAL OF SOLAR AIR VENTILATION

Canadian figures are not readily available on the job creation potential for the solar air ventilation industry. Nevertheless, extrapolation of the present size of the industry versus new annual installations can provide a rough estimate of the magnitude of potential job creation.

According to Industry Canada, in 2003 there were 60 jobs and about 4,000 m<sup>2</sup> of solar air ventilation systems installed (manufacturer estimate). This would roughly translate to about 15 jobs per 1,000 m<sup>2</sup> of installed solar air ventilation systems (which is a very high employment estimation when compared to other solar technologies). Therefore, a preliminary estimate of five jobs per 1,000 m<sup>2</sup> is used, and it is emphasized that further research is required to derive a more accurate estimate.

#### ONTARIO'S SOLAR JOB MARKET

Life expectancies of most solar technologies exceed 25 years, which is greater than the time frame considered in this study. However, as the market ages, there will be a growing need for system replacement, which will increase the job market. Solar pool heating – which has a typical life expectancy of 15–20 years will begin to see a significant replacement market develop during the next 20 years. However, this is not considered in the estimates used here.



**TABLE 3**  
Solar technology area requirements for residential applications

Technology	System size	Solar system surface area (m <sup>2</sup> )
Passive solar	To provide 33% of space heating load	7
PV	3 kW array	20
Solar DHW	2 collector system	6
Solar pool heating	50% of pool surface area – average pool of 16'x32'	26

The data of Table 3 is used to consider the available space on each roof type, considering its potential for shading, which is then compared to the size requirements for each solar application. Table 4 illustrates the results of this calculation and assumes that new construction (beginning in 2008) uses good solar orientation design and that favourable legislation protecting solar access is in place.

**TABLE 4**  
Estimate of housing stock available for solar applications

Technology	System sizing	Current (2001)	2025
Passive	With optimum solar exposure	12%	23%
PV	3 kW Array	47%	51%
Solar DHW	For single family dwellings	63%	77%
Solar pool heating	For average swimming pool	39%	39%

Considering provincial data on floor area and the number of building stories it is possible to derive estimates of Ontario's available roof space on commercial and institutional buildings.<sup>31</sup> This calculation indicates that

by 2000 there were approximately 44 million m<sup>2</sup> of roof space on commercial and institutional buildings in Ontario.

By extrapolating historical building growth rates in Ontario it is possible to estimate that the building roof area in 2025 could increase to as high as 67 million m<sup>2</sup>.<sup>32</sup>

#### TECHNICAL POTENTIAL FOR PHOTOVOLTAIC SYSTEMS

**Residential PV:** Based on historical housing construction data, it is estimated that the number of houses in Ontario could grow to over 5,000,000 units by 2025.<sup>33</sup>

Currently, about 1,400,000 homes in Ontario (47% of all homes) have the potential to install a 3 kWp solar PV array that combined could supply 17% of the residential plug load demand in Ontario.<sup>34</sup>

Based on no improvements to homes' orientation or solar exposure it is possible to estimate that by 2025 almost 2,400,000 homes would have the technical potential to install a 3 kWp PV array, and that the total technical potential would be 7,100 MW or 7,100 GWh.

With proper legislation solving solar access and house orientation issues, the number of feasible roofs for 3 kW PV arrays for new homes could rise from the current 46% to 62% by 2025, thereby increasing the total housing stock's potential to 51% of all homes. This could increase the technical potential for PV-generated electricity by 11% to 7,900 MW (7,900 GWh) in 2025.

**Commercial & institutional rooftop PV:** It is assumed that 50% of commercial/institutional buildings currently have the potential for supporting PV systems on their roofs. It is important to note here that there is an overlap of the space requirements between PV and solar hot water systems. As the deployment of these two technologies

**TABLE 5**  
Residential grid connected PV current technically feasible potential (2001)

	Single detached	Semi attached	Row	Total
Number of housing units	2,456,925	263,875	307,665	3,028,465
Feasible sites	44%	52%	57%	47%
Number of feasible sites	1,081,047	137,215	175,369	1,393,631
Solar array size (kW)	3	3	3	
Technically feasible (MW)	3,243	412	526	4,181
Annual energy (GWh)	3,243	412	526	4,181
<b>Percent of total demand</b>				<b>17%</b>



**TABLE 6**

Residential grid connected PV technical potential in 2025

	Single detached	Semi attached	Row	Total
Housing units – to 2008	2,730,349	312,466	382,809	3,425,624
Feasible sites	44%	52%	57%	46%
Subtotal – feasible housing units	1,201,354	162,482	218,201	1,582,037
Housing units– built – 2008–2025	1,133,586	250,533	283,752	1,667,871
Feasible sites	59%	65%	75%	62%
Subtotal – feasible housing units	668,816	162,846	212,814	1,044,476
Total Number of Feasible Housing Units	1,870,169	325,329	431,015	2,626,513
Solar Array Size (kW)	3	3	3	
Technically Feasible (MW)	5,611	976	1,293	7,880
<b>Annual Energy (GWh)</b>	<b>5,611</b>	<b>976</b>	<b>1,293</b>	<b>7,880</b>

increases significantly there will be competition for roof space between the technologies.

Furthermore, it is also assumed that only 60% of the eligible roof space for solar systems is available for installations of PV as space is already taken up by HVAC equipment, roof access for window cleaners, and the spacing required between solar arrays to prevent array shading. As part of the technical resource calculations it is also assumed that PV modules will improve their performance efficiency slightly during the period considered (i.e. increase from 129 to 142 watts per m<sup>2</sup>). Taking these numbers into consideration, it is estimated that the technically feasible potential of commercial rooftops in 2025 is 4,046 MW (or 4,046 GWh annually).

**Commercial and institutional facade BIPV:** Data on the fraction of wall area with adequate solar insolation for a wall mounted PV is derived from a European Commission report and data from German cities.<sup>35</sup> Applying this data, it is estimated that an average of 8%

of building wall space has the potential for solar PV. A lower capacity fraction (0.61 kWh/watt vs. 1.0 kWh/watt) is used due to the reduced insolation on a vertical wall versus a sloped roof.

**TABLE 7**

Commercial rooftop PV – technically feasible potential (2000 &amp; 2025)

Year	2000	2025
Total number of buildings	52,182	78,368
Feasible sites	50%	50%
Number of feasible buildings	26,091	39,184
Roof area (m <sup>2</sup> )	44,878,716	67,399,524
Average roof area (m <sup>2</sup> )	860	860
Available roof area	60%	60%
PV array tilt aspect (45° vs. flat)	141%	141%
Average array area available (m <sup>2</sup> )	728	728
PV efficiency (watt/m <sup>2</sup> )	129	142
Average array size (kW)	94	103
Total power (MW)	2,449	4,046
Annual energy produced (GWh)	2,449	4,046

**TABLE 8**

Commercial/institutional building facade BIPV (2025)

	2000	2008	2025
No. of buildings	52,182	59,434	78,368
Wall area (m <sup>2</sup> )	1,797,476,509	2,047,295,229	2,699,477,007
Increase in wall area			652,181,779
Fraction of facade available for BIPV			25%
Fraction of façade with adequate solar irradiation			8%
Façade available for PV (m <sup>2</sup> )			13,043,636
PV efficiency (watt/m <sup>2</sup> )			142
Total power (MW)			1,852
Annual energy output (kWh/watt)			0.61
Annual energy produced (GWh)			1,121

Table 9 illustrates that the total technically feasible potential for PV in Ontario by 2025 is equivalent to 13,778 MW.

**TABLE 9**

Ontario's grid connected PV technically feasible potential (2025)

Building type	Capacity (MW)	Energy (GWh)
Residential rooftops	7,880	7,880
Commercial rooftops	4,046	4,046
Commercial façade BIPV (new buildings)	1,852	1,120
<b>TOTAL</b>	<b>13,778</b>	<b>13,046</b>

#### TECHNICAL POTENTIAL FOR SOLAR AIR VENTILATION

The current markets for solar air ventilation are primarily in the commercial/institutional and industrial markets where large volumes of fresh air are required. These two markets are analyzed separately due to the different methods used to report energy use.

**Solar Air Ventilation (SAV) for commercial/institutional buildings:** This chapter considers the potential only for new construction occurring between 2008–2025. By displacing costs associated to new construction with SAV, the economics improve dramatically and it is assumed that this market will develop faster than the retrofit market. Limiting the study to new construction will underestimate the technically feasible potential considerably. However, the numbers will more closely reflect the market potential. Projections on the amount of new wall area through to 2025 were based on historical data of buildings, average number of floors, and floor area in commercial/institutional buildings.<sup>36</sup>

It is assumed that about 8% of walls on all new buildings have the potential of using SAV; however it is estimated that only 10% of those walls are available for solar air ventilation systems (the remainder being used for windows, doors, or shaded). This would indicate that the technically feasible potential would be about 0.8% of all wall space. Assuming that the necessary mechanisms to reduce the barriers to this technology are introduced by 2008 then this would equate to 650,000,000 m<sup>2</sup> of potential wall space and an annual energy output of 10 PJ by 2025 in commercial buildings.

**Solar air ventilation for industrial buildings:** Estimating the technically feasible potential for industrial buildings is difficult because building size data is not

readily available. Furthermore, available energy usage data is not separated between different building loads (such as process energy and operational building energy needs). Therefore, it is estimated here that if changes in building orientation are introduced after 2008 then the sites where solar can be used could increase from 25% to 50%.<sup>38</sup> It is estimated that SAV has the technical potential to supply 3.95 PJ in the industrial segment by 2025.

**TABLE 10**

Technical potential of commercial solar air ventilation in Ontario by 2025

	2000	2008	2025
No. of buildings	52,182	59,434	78,368
Wall area (m <sup>2</sup> )	1,797,476,509	2,047,295,229	2,699,477,007
Increase in wall area			652,181,779
Fraction of façade with adequate solar irradiation			8%
Fraction of façade available for solar air ventilation			10%
Façade available for solar (m <sup>2</sup> )			5,217,454
Energy output @ 2 GJ/m <sup>2</sup> (PJ) <sup>37</sup>			10

**TABLE 11**

Current industrial SAV technical potential in Ontario

	Feasible	Fuel (PJ)	Solar (PJ)
Electrical	3.75%	6.34	0.24
Gas	3.75%	18.05	0.68
<b>Total</b>		<b>24.39</b>	<b>0.91</b>

**Total technically feasible potential for Solar Air Ventilation (SAV):** It is estimated that the technically feasible potential for SAV in Ontario for new buildings (built after 2008) can be 14 PJ. However, the market considered in this study represents only about 24% of all non-residential buildings, and thus the total technical potential could be in the range of 56 PJ (15,500 equivalent GWh). However, we have used the lower number (14 PJ) in this chapter.

#### TECHNICAL POTENTIAL FOR SOLAR HOT WATER (SHW)

Technical estimates are broken down according to residential, commercial, and swimming pool sectors.

**Residential solar water heating:** It is estimated that 2,228,000 residences in Ontario could use solar energy for heating water. This total could rise to 4,737,000 housing units by 2025 with proper house planning and adequate solar access legislation in place.<sup>39</sup>

**TABLE 12**

SDHW technical feasible percentage of homes

		Single detached	Attached	Apartments (low-rise)	Total
2001	Number of housing units	2,456,925	571,540	1,166,475	4,194,940
	Feasible sites	63%	65%	27%	53%
	Potential no. of solar units	1,547,863	371,501	309,116	2,228,480
2025 no planning	Number of housing units	3,863,935	1,229,560	1,772,427	6,865,922
	Feasible sites	63%	65%	27%	54%
	Potential no. of solar units	2,434,279	799,214	478,555	3,712,048
2025 w legislation	Number of housing units	3,863,935	1,229,560	1,772,427	6,865,922
	Feasible sites	77%	90%	37%	69%
	Potential no. of solar units	2,975,230	1,106,604	655,798	4,737,632

Table 13 summarizes Ontario's total residential hot water use by dwelling type.

**TABLE 13**Ontario's residential hot water usage (2001)<sup>40</sup>

	Single detached	Attached	Apartments	Mobile homes	Total
2001 (PJ)	61.7	16.5	30.3	0.8	109.2

Currently 63% of Ontario's single detached homes have the technical potential to install a solar water heater. The average total amount of hot water that can be supplied using solar currently is about 42% in Ontario.<sup>41</sup>

The technically feasible potential of SDHW in 2025 relates, to a large amount, to how buildings will be built. If new homes are installed using current practices (i.e. no consideration to building orientation as it relates to southern exposure or seasonal cycles) then technically feasible potential in 2025 will be 37.1 PJ.

If housing units are oriented correctly to take advantage of available solar resources and solar access legislation is enacted to ensure maximum use and unimpaired access to solar resources, then the potential rises from 63% of single detached homes to 77% and the technically feasible potential rises to 56.4 PJ by 2025.

**TABLE 14**

Solar domestic hot water (SDHW) technically feasible potential (2001)

	Single detached	Attached	Apartments	Mobile homes	Total
Feasible sites	63%	65%	27%	0%	
Solar fraction	42%	42%	42%	42%	
Technically feasible	26%	27%	11%	0%	
Annual solar energy (PJ)	16.3	4.5	3.4	0.0	24.2

**TABLE 15**

SDHW technically feasible potential (2025) – with planning

	Single detached	Attached	Apartments	Mobile homes	Total
Feasible sites	77%	90%	37%	0%	
Solar fraction	50%	50%	50%	50%	
Technically feasible	39%	45%	19%	0%	
Annual solar energy (PJ)	35.1	15.6	5.7	0.0	56.4

**Commercial Solar Hot Water (SHW):** In 2001 the commercial sector used about 24.8 PJ for its hot water needs. Natural gas was used to provide close to 95% of the energy needed to heat water in this sector (oil and electricity provided the remainder). The estimated number of commercial sites where it is technically feasible to use solar water heating and the potential of solar is listed in the Table below.<sup>42</sup> As most commercial buildings have flat roofs and are multi-storey (implying low shading issues), then the fraction of technically feasible sites is not expected to increase significantly through to 2025. Solar water heating has the technical potential to provide 8.8 PJ of the hot water needs of the commercial building segment by 2025.

It should be noted that there is a very high potential for commercial solar water heating in specific market segments, most specifically hot water intensive industries such as food processing, because installed costs are lower and energy consumption can be very high. More research is required into this market segment to highlight opportunities.

#### SOLAR HEATING OF SWIMMING POOLS

It is estimated that the pool market in Ontario will grow from 207,000 (1998) to 415,500 by 2025 and that 59% of pools will continue to be heated (10% from solar). Based on the present market and business-as-usual scenario,

**TABLE 16**

## Commercial solar water heating potential

Building type	2001	Technically feasible sites	Typical solar fraction	Technically feasible	Annual solar energy (2001)	Annual solar energy (2025)
	PJ				PJ	PJ
Schools	2.5	60%	42%	25.2%	0.63	0.92
Health care institutions	4.9	60%	42%	25.2%	1.23	3.92
Religious institutions	0.8	60%	42%	25.2%	0.20	0.24
Other institutions	2.0	40%	42%	16.8%	0.34	0.86
Offices	5.1	0%	42%	0.0%	–	–
Retail organizations	2.7	5%	42%	2.1%	0.06	0.10
Hotels and restaurants	4.5	40%	42%	16.8%	0.76	2.17
Recreational facilities	1.8	40%	42%	16.8%	0.30	0.48
Warehouses	0.6	40%	42%	16.8%	0.10	0.12
<b>Total</b>	<b>24.8</b>				<b>3.62</b>	<b>8.8</b>

pools that are heated using solar energy could grow from the current 22,500 (2001) to 41,500 pools in 2025.

Currently it is estimated that there are over 22,000 pools in Ontario that are solar heated and it is estimated that a further 43,000 pools could potentially use solar heating with a savings of 2.6 PJ of conventional energy sources.

Based on these figures it is estimated that 39% of pools have the potential of using solar energy, which indicates a technically feasible market of 120,000 pool installations by 2025.

**PASSIVE SOLAR DESIGN (PSD)**

The technically feasible residential potential of PSD in Ontario is 145 PJ annually by the year 2025, based on estimates for new house construction in Ontario and on the feasibility of using solar energy in buildings.

Passive solar energy can play a significant factor in reducing the energy demand in large buildings. However, it is beyond the scope of this chapter to cover this wide topic. There is a lack of current Canadian studies available

in this area and a proper study should be conducted to identify the potential and possible mechanisms on how solar can contribute more to this building sector. The few existing Canadian reports on this topic indicate that solar daylighting provides over 25% of the lighting energy required in large buildings (daylighting refers to the use of natural light to illuminate buildings rather than relying on artificial lights powered by electricity).<sup>44</sup> The contribution can be increased to 30–70% where daylighting designs are used, and this is an important solar option as lighting loads can account for 10–20% of electricity use in large buildings.<sup>45</sup>

**2.3 PRACTICAL RESOURCE**

Although Ontario's technical solar potential is very large, its development is constrained by a number of physical factors, and by what is considered a financially viable market share.

No recent studies have been done in Canada on levels of market share as they relate to payback for renewable

**TABLE 17**Current (2001) potential for solar pool heating in Ontario<sup>43</sup>

	Resistance heater	Natural gas/propane	Heating oil	Heat pump	Electricity (res & heat pumps)	Total
Energy supplied by source	3%	39%	0%	6%	9%	
No. of pools	7,196	87,700	–	14,167	21,363	109,063
Energy supplied by source (PJ)	0.3	3.9	–	0.6	0.9	4.8
Heater efficiency	100.0%	67.5%		100.0%	100%	
Energy consumed (PJ/year)	0.3	5.7		0.6	0.9	
Feasible sites for solar	39%	39%		39%	39%	
No. of pools with solar potential	2,806	34,203		5,525	8,332	42,535
Energy savings (PJ/year)	0.1	2.2		0.2	0.4	2.6
<b>Energy savings (GWh/year)</b>	<b>34</b>	<b>620</b>		<b>68</b>	<b>102</b>	

energy systems. However, it is reasonable to assume that a significant shift in public attitudes may have occurred since the late 1980s when the last report on this issue was done.<sup>46</sup> Therefore, it is recommended that the province initiate a study of this issue as soon as possible.

For the remaining resource estimations of this chapter the payback acceptance curve that was developed in 1989 by Synergic Resources Corporation was used due to the lack of a more current model. The figure below shows the percentage of buyers that would purchase an energy-saving device for the residential, industrial, commercial and institutional markets. It is important to emphasize that currently there is essentially no market demand for products with greater than a seven to eight-year payback (except by innovators).<sup>47</sup>

While institutions and governments often claim to accept longer paybacks than industry, tight budgets and capital spending limitations cause only the most cost-effective measures to be implemented unless the purchases are legislated.

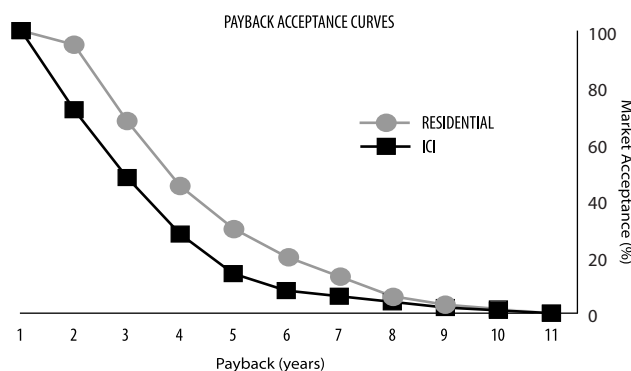

FIGURE 8 Technology acceptance based on payback

Deployment estimates for solar technologies are based on these curves (with reference to the technical potential of each solar segment).

In addition, it needs to be considered that a small industry may be able to sustain double or even triple digit growth for short periods of time (five years or less) when the market penetration is extremely small. Moving from sales of 100 units to 300 units is easier to accomplish than a sales increase from 100,000 to 300,000 though the growth rate is still the same. For the analysis of resource potential, it is estimated that the short-term sustainable growth of the solar industry is 50% annually.

This estimate assumes that the crucial issues outlined below will be addressed by policy-makers to thereby achieve the solar development potential summarized here.

**Manufacturing capacity:** Manufacturing plant capacity can be a limiting factor when large sales growth is experienced, as it may take a year or more to build new capacity. Therefore, industrial planning and innovation needs to be actively fostered and supported by all levels of government.

**Expansion of the workforce:** Training of the workforce can have a major limiting effect to growth. Solar technologies require labour with special training to ensure that systems are properly designed and installed, and that they operate at optimum performance. Current initiatives such as the Renewable Energy Program of the Association of Canadian Community Colleges provide a valuable example of the type of programs that need to be augmented and designed for the secondary and post-secondary systems.<sup>48</sup>

**Access to working capital:** The solar industry in Canada currently consists of small firms. Small businesses historically have a difficult time accessing capital. Solar businesses represent unknown territory for most investors, and therefore have an extremely difficult time raising capital at favourable terms. This problem represents a major limit to how fast the solar industry can grow and to be addressed (for example, through education initiatives and active industry-government collaborations).

**Access to finance and performance incentives:** Although some solar technologies are already cost-competitive in Ontario when initial costs are accounted over the life of the system (e.g. solar water heaters, solar ventilation), others are still not (e.g. grid-connected PV). Access to finance at attractive interest rates (for example through interest-free or low-interest revolving loans) is essential to enable sustained and large-scale adoption of solar systems, and needs to be coupled with renewable energy mechanisms that allow system owners to receive an adequate payment for each kWh of excess power that their systems produce.

## 2.4 ACCEPTABLE RESOURCE

### PHOTOVOLTAIC (PV)

It is impossible to accurately predict what constitutes an acceptable market potential of PV in Ontario by 2025 without a prediction of electricity prices and PV cost reductions, which are beyond the scope of this chapter. PV is currently not in the same situation as the other

solar technologies discussed here, which have payback periods ranging from 1–10 years, and that have as a main barrier the financing of systems over a medium (10-year) time frame.

Nevertheless, it can be safely assumed that PV’s growth potential is increasing each year as electricity prices grow and its installation costs are reduced.

The charts below illustrate two potential scenarios. Scenario 1 assumes that PV prices continue to drop by 5% annually (historical average), electricity prices in Ontario increase by 4% annually with a starting price of \$0.08 per kWh, and that solar is amortized over 20 years. In this scenario PV achieves the cost of utility supplied electricity by 2024.

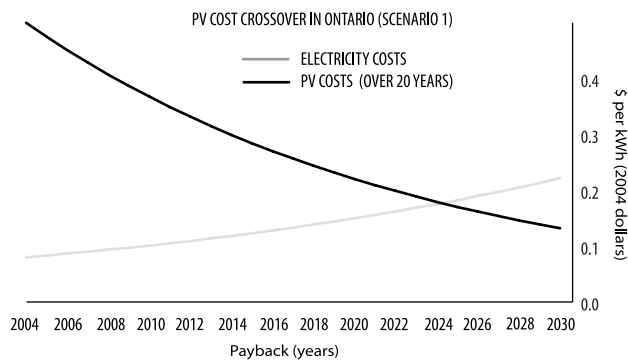

FIGURE 9 PV cost crossover in Ontario (Scenario 1)

The second scenario uses the cost of electricity at peak times (assumes 50% above the average). Solar PV produces electricity during peak times, and the benefits and savings will be greater if this is taken into consideration. In this scenario the cost of solar is amortized over 30 years (most PV modules have a 25-year warranty with a minimum life expectancy exceeding 40 years). In this scenario the crossover point of solar PV occurs 9 years earlier, in 2015.

If prices were to drop quickly to \$5.50 per watt installed (currently they are in the range of \$10/watt installed) as has been suggested, or as the peak cost of

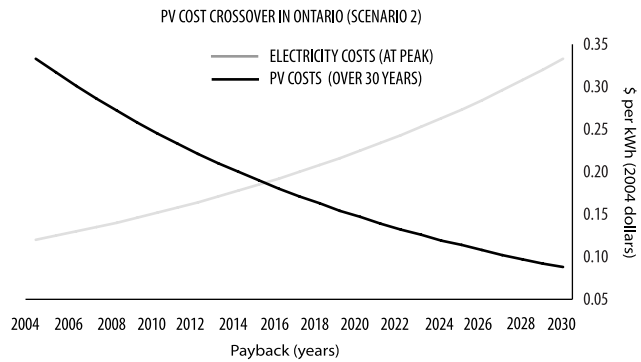

FIGURE 10 PV cost crossover in Ontario (Scenario 2)

electricity increases faster (middle of day prices are 50–100% higher than the rates currently billed) then the cost crossover point could occur considerably sooner.<sup>49</sup>

The estimate on potential solar markets in 2025 are based on the following:

- An early adopters program funded by REM;
- A provincial Net Zero Energy Homes initiative for new homes;
- A BIPV program on government buildings and schools.

With an “Accelerated PV Price Drop” scenario with a cost crossover occurring in around 2015, it is estimated that 1,263 MW of PV, generating 1,263 GWh, could be installed on the electrical grid by 2025 with government support for REMs.

This estimate is comparable to the one suggested by a recent Pembina Institute/Canadian Environmental Law Association report (1,000 MW by 2020).<sup>50</sup>

As the cost crossover point is approached, the issue of deployment growth becomes one of financing the installation costs (similar to the current situation faced by solar domestic hot water systems), rather than that of the economics of electricity generation from PV.

In addition there are significant industry barriers, including limits to an industry’s sustainable growth that must also be addressed before higher PV installation

TABLE 18

PV in Ontario – the market potential (2025)

Early adopters program	1,000 homes a year for 10 years	10,000 homes	30 MW	30 GWh
NZEH initiative	2% incremental growth rate of new home construction	420,000 homes	1,232 MW	1,232 GWh
BIPV demonstration	100 kW per year for 10 years		1 MW	0.6 GWh
<b>Total installed</b>			<b>1,263 MW</b>	<b>1,263 GWh</b>

numbers are achievable. The province needs to prepare itself for the wide introduction of PV on the grid and therefore it is critical that the provincial government initiates a number of programs to increase the solar industry's capacity to handle rapid growth, and to educate policy and decision makers on the multiple environmental and social benefits of PV and its significant expansion potential.

#### SOLAR AIR VENTILATION (SAV)

Assuming the current annual growth rate of 6.5% for SAV would mean that the industry would supply 0.31 PJ of energy by 2025.

Under an accelerated scenario, considering the market potential for solar air ventilation systems by 2025, it is assumed that a key caveat is the amount of growth that the SAV industry can maintain over an extended time frame. Therefore, it is estimated as an annual growth of 50%, starting in 2008 for five years, and then an annual growth of 30% thereafter.

**TABLE 19**

The market potential of SAV in Ontario

	Business		
	as usual	Accelerated	Increase
Annual growth rate	6.50%	30–50%	
Annual installed in 2025 (m <sup>2</sup> )	9,000	825,000	816,000
Total installed by 2025 (m <sup>2</sup> )	156,000	3,586,000	3,430,000
Annual sales (2025)	\$19.5M	\$363M	\$343M
Cost reductions (annual)	0%	1%	

In the accelerated scenario it is projected that an additional 816,000 m<sup>2</sup> of solar air ventilation systems could be installed annually by 2025 in commercial and industrial buildings in Ontario – this represents the manufacturing capacity that already currently exists in Ontario. Although current manufacturing capacity is focused to satisfy foreign demand, it is estimated that the industry could manage the expected growth in production. The availability of a trained workforce is not considered to be a barrier as workers can be drawn from the existing construction industry. By increasing the sales to the accelerated scenario it is estimated that the SAV industry could reduce costs by an average of 1% annually due to economies of scale.

By 2025 the commercial and industrial solar air ventilation potential in the accelerated growth scenario would contribute over 7.17 PJ (or the equivalent of 1,991 GWh per year). This solar contribution represents about 50% of the technical potential in this market segment.

#### SOLAR HOT WATER (SHW)

Two scenarios are considered in this section. The first is based on a business-as-usual scenario that assumes an annual growth rate of 10% for the current SHW market. The accelerated scenario assumes that a financing program is in place with a pilot program initiated in 2005 (700 systems in two years), which is then followed by annual sales growth of 50% a year (achieving 5,000 system installations annually by 2011) for five years and then growing at current typical international growth rates of 30% over the remaining period (2012–2025).

It is assumed that growth limitations are not relevant in the SHW industry because there is current capacity in Canada to manufacture over 40,000 residential systems annually and the Canadian domestic market is very small compared to international markets.<sup>51</sup>

Based on the accelerated adoption scenario, it is estimated that over 800,000 solar residential hot water systems could be installed in Ontario by 2025 and a further 2,000,000 m<sup>2</sup> of solar collectors could be installed for commercial systems.

**TABLE 20**

SHW market potential (2025)

		Business	
		as usual	Accelerated
Total Installed	m <sup>2</sup>	53,000	6,800,000
	Energy (PJ)	0.103	13.57
	Energy (eGWh)	29	3,772
Residential	m <sup>2</sup>	35,000	4,800,000
	Systems	5,800	800,000
	Energy (PJ)	0.070	9.600
Commercial	m <sup>2</sup>	1,655	2,000,000
	Energy (PJ)	0.033	3.969
System Cost in 2025		\$3,500	\$2,290
<b>Total Sales (2005–2025)</b>		<b>\$31M</b>	<b>\$2,990M</b>

#### SOLAR HEATING OF SWIMMING POOLS

While this is a mature market that does not require government support to continue growing at the same rate as new pool installations – it remains stuck with about a 10% market share for pool heaters. The main impediment to increasing sales in this market is the lack of customer familiarity with the product (i.e. insufficient marketing), a reluctance of pool installers to sell solar systems due to the perceived complexity of the installation (i.e. lack of information) and the higher initial investment that is required for solar systems versus heaters that use non-renewable energy sources (payback acceptance curve).

Removing marketing and education barriers could improve the market share to 45% based on a three-year payback acceptance curve for solar pool heaters.

If a financing mechanism was introduced to reduce payback time to one year, the market share could increase to close to 100% of its technically feasible market. This would improve the market for solar pool heating from the business-as-usual scenario of 41,000 systems installed, to 120,000 systems by 2025 – representing 29% of all pools and 49% of all heaters. A large market share in the heater market is viable as solar heaters do not in all cases replace an existing heater (e.g. the original heater can be still be used to back up the solar system).

**TABLE 21**

The market potential for solar pool heating by 2025

By 2025	Business as usual	Accelerated growth
Installed	41,000 systems	120,000 systems
Increase	16,500 systems	95,500 systems
Sales (2005–2025)	\$65M	\$390M
Energy produced in 2025	1.9 PJ	6.6 PJ

No major industry growth barriers exist, as the Ontario market size is still small and the labour force could be drawn from the pool industry and summer students. An accreditation program for the companies who would install under the proposed incentive program summarized in Table 24 would ensure that installations are done properly.

#### PASSIVE SOLAR DESIGN (PSD)

By improving the building stock of new homes in Ontario starting in 2008, it would be possible to achieve a market potential for residential PSD in Ontario by the year 2025 of 86 PJ (or the equivalent of 23,800 GWh) annually. To visualize the potential of this contribution, consider that in 2001 Ontario's total load of space heating required about 299 PJ of energy, which was provided predominantly by natural gas.<sup>52</sup>

## 2.5 ONTARIO'S ACHIEVABLE SOLAR CONTRIBUTION

### ONTARIO'S SOLAR POTENTIAL IN 2010

As the solar market and the solar industry in Canada is so small, significant growth must occur before solar technologies begin to make a significant impact. If the initiatives recommended in this chapter are implemented by 2008 then the impact of solar technologies by 2010

will still be at an incipient stage. However, the compound double-digit growth that solar technologies have consistently experienced will allow the solar sector to be a significant source of Ontario's energy by 2025.

**TABLE 22**

Solar energy use in Ontario (2010)

Application	Solar total (PJ)	Total solar systems
Residential		
Solar DHW	0.11	9,500 systems
Swimming pools	1.50	35,000 systems
PV on homes	0.24	25,000 systems
Passive solar heating	29.00	22,000 homes
Commercial & Institutional		
Solar hot water	0.04	20,000 m <sup>2</sup>
PV on roof tops	0.001	300 kW
BIPV facades	0.0007	300 kW
Industrial & Commercial		
Solar air ventilation	0.17	83,000 m <sup>2</sup>
Total		
Total energy (PJ)	31.06	
<b>Total energy (GWh)</b>	<b>8,628</b>	

### ONTARIO'S SOLAR POTENTIAL IN 2025

Solar energy has the technically feasible potential of supplying 21% of the energy in the market segments reported on this study by 2025. Half of this technical potential could be achieved if the initiatives discussed in this chapter are implemented. At this level of adoption, solar energy would provide as much energy in 2025 as coal did in 1999, or about half the electricity generated by all of Ontario's nuclear power plants.

**TABLE 23**

The market potential for solar by 2025

Application	Solar total (PJ)	Total solar systems
Residential		
Solar DHW	9.60	800,000 systems
Swimming pools	6.60	120,000 systems
PV on homes	4.54	430,000 systems
Passive solar heating	85.67	420,000 homes
Commercial & Institutional		
Solar hot water	3.97	2,000,000 m <sup>2</sup>
PV on roof tops	0.004	1000 kW
BIPV facades	0.002	1000 kW
Industrial & Commercial		
Solar air ventilation	7.17	825,000 m <sup>2</sup>
Total		
Total energy (PJ)	117.56	
<b>Total energy (GWh)</b>	<b>32,656</b>	



## 2.6 GROWTH QUICKENS IN NEW MARKETS

Surveys of the world's PV market consistently show that growth rates of 30% or more have become an established trend.<sup>53</sup> These high growth rates are leading to a general continuing downward trend in grid-connected PV system prices.<sup>54</sup> Analysis of the long-term outlook for the leading PV markets of Japan, Germany, and California shows that these markets will continue to grow.<sup>55</sup>

The quick rise and sustained buoyancy of the German and Japanese markets are a direct result of government implementation of supportive market transformation policies. Germany's PV leadership in Europe is a direct consequence of the implementation of its sophisticated renewable energy feed-in law, which mandates that utilities connect PV systems to the electric grid and that they purchase electricity at fixed minimum prices.

In addition to this key policy strategy, Germany and Japan have implemented initiatives to provide access to system finance ("solar roofs" programs), and comprehensive education programs that act synergistically to creative active solar PV markets.<sup>56</sup>

Markets for solar water and space heating are also increasing at impressive rates and provide examples of what can be achieved in Ontario. For example, between 2000 and 2001 these markets grew by 26% per year, while the market of solar swimming pool heating grew by 23%.<sup>57</sup> All solar thermal systems installed by the end of 2001 generated the equivalent of 41,795 GWh (150,463 TJ), which corresponds to an oil equivalent of 6.7 billion litres, and helped to avoid the annual emission of 18.2 million tonnes of CO<sub>2</sub>.<sup>58</sup>

Solar thermal markets are currently dominated by China's domestic demand (which has an ambitious national target of 65 million m<sup>2</sup> of solar collectors by 2005 in its 10<sup>th</sup> Five Year Plan) and by Germany, which has achieved a ten-fold market expansion since 1991. Germany currently offers generous market incentives for thermal systems and is exploring the potential of adapting its feed-in laws to the solar thermal sector. Other market success stories include Israel, which 20 years ago introduced legislation requiring new buildings to place solar thermal systems on their roofs and can boast today that 80% of all its residential buildings are now equipped with solar water heaters.<sup>59</sup>

## 3. Policies, mechanisms, and incentives to enhance solar power implementation

### 3.1 SOLAR ELECTRICITY (PV)

While all the solar thermal technologies discussed in this chapter are cost-effective and ready for wide deployment in Ontario, there are still significant barriers surrounding the use of PV in grid-connected applications. Government involvement is essential to facilitate dismantling key barriers such as inadequate price incentives, poor access to finance, and limited public awareness, which are actively preventing the widespread use of PV in the province.

More specifically, residential and commercial customer participation in the implementation of grid-connected PV in Ontario are hampered by:<sup>60</sup>

- Cumbersome access to the grid for owners of PV systems;
- Lack of guaranteed premiums for PV-generated electricity;
- Very limited provincial awareness on the current options available for using PV and PV's numerous financial and non-financial benefits;
- Technological availability and high initial cost;
- Poor financing rates and terms.

Many of these issues can be addressed through strong program design. However, to maximize provincial participation it is necessary to have effective policy mechanisms that go beyond the net-metering approach currently used in North America. The fact is that without other financial incentives, net metering is not enough to increase market penetration as the experience of California and Texas clearly illustrates.<sup>61</sup>

The successful PV programs of the two world leaders on this technology, Japan and Germany, clearly illustrate the effectiveness of innovative policy mechanisms such as feed-in laws (referred here as renewable energy mechanisms or REMs), and the importance of a combination of other supportive initiatives to overcome barriers (government support of public education, R&D, training, access to finance).

REMs have two essential components: stable and carefully calculated payments for each kWh of PV-generated electricity (which are regularly reviewed to

ensure market development), and the right to connect to the electricity grid.

The design and implementation of REMs in Ontario needs to be supported by a provincial PV Deployment Program that addresses the following issues:

#### EDUCATION AND COMMUNICATION

- Renewable energy education programs to build demand for distributed renewables and increase the public interest in PV;
- Effective tracking and monitoring of program initiatives to identify and correct barriers to the wider use of PV.

#### TECHNICAL ISSUES

- Clear and simple interconnection standards that are uniform across Ontario and compatible with those in other provinces;<sup>62</sup>
- Support for equipment suppliers by facilitating testing and certification by a standards testing agency (such as CSA or Measurements Canada), and by listing in a directory of certified suppliers.

#### FINANCING ISSUES

- Development of favourable financing mechanisms for customers purchasing distributed renewable energy systems (e.g. a federal-provincial interest-free revolving loan system to facilitate purchase of PV systems);
- Simplified and standardized contracts for potential PV implementers.

An action plan for mainstreaming PV in Ontario should focus on a number of separate, yet interdependent initiatives:

- An early adopters program (for existing homes);
- A net-zero energy home initiative (for new homes);
- A Building Integrated PV (BIPV) demonstration program using government buildings to showcase the technology and stimulate learning by doing;
- Solar access legislation including zoning and building code strategies to protect solar access and to prepare new homes for PV retrofits (so new homes can be solar-ready even if systems are not implemented at the time of construction);
- A PV financing program (e.g. a federal provincially-

sponsored revolving program to provide interest free loans);

- A public awareness education program.

### 3.2 SOLAR THERMAL

#### SOLAR AIR VENTILATION (SAV)

Currently there are three main barriers to the greater deployment of SAV systems in Ontario:

- Lack of knowledge about the product and its features and benefits (including a reluctance of the design community to specify solar heating);
- A payback period of four to six years (for new construction), which reduces the potential market to under 20% of potential buyers using the payback acceptance curve;
- Owners of commercial buildings are usually not the energy consumers and there is little incentive for owners to install energy saving equipment as the energy bills are passed directly on to the tenants.

If these barriers were eliminated, then the market for solar air ventilation would achieve the accelerated scenario by 2025.

Support initiatives for SAV would include solar access legislation, solar-ready standards and codes for new buildings, solar certification and listing in an ad-hoc directory, tax incentives, and solar procurement by government. More details are provided on these initiatives below.

#### SOLAR HOT WATER (SHW)

Currently there are three main barriers to the greater deployment of solar hot water systems in Ontario:

- Lack of knowledge of the product, its current features, and numerous benefits.
- Current payback periods of 7–15 years, which reduce the potential market to under 5% of potential buyers.
- For commercial systems the owners of commercial buildings are usually not the energy consumers and there is little incentive for them to install energy saving equipment as the energy bills are passed to the tenants.

If these three main barriers were eliminated then the market for solar hot water systems would achieve the accelerated scenario by 2025.

Support initiatives for SHW would include solar access legislation, solar-ready standards and codes for new buildings, solar certification and directory, tax incentives, expanded tax write-offs, promotion of SWH as part of a zero-energy home program, and solar procurement by government. More details are provided below.

#### SOLAR POOL HEATING (SPH)

The primary barriers to wider deployment of solar pool heating relate to a lack of coordinated marketing and the need for system financing.

While this market's energy needs can be considered as a relatively small fraction of Ontario's total energy needs, the solar contribution of this market can be quite significant (with the equivalent of potential savings of 1,330 GWh annually by 2025).

A government program for solar installations in this segment can have high synergistic potential to increase residential and commercial hot water markets and can be rapidly deployed. It would also send a strong message to Ontario residents about the government's commitment to developing solar technologies.

Support for SPH would include solar access legislation, solar certification and listing in an ad-hoc directory, special promotion programs, and tax incentives. More details are provided below.

#### PASSIVE SOLAR (PS)

Many of the initiatives for increasing the deployment of passive solar to reach maximum market potential by 2025 relate to policy and legislation. Passive solar is cost-effective now, as it is mainly a design issue with no significant materials costs. The main barriers to a wider use of the technology in Ontario include:

- Lack of information on its potential;
- Lack of demonstrations throughout Ontario;
- Builders have no incentive to build houses with a high solar fraction, as there is no market demand at the moment nor legislation to ensure the maximum possible use of PS design;
- Buildings do not have dedicated access to the solar resource (as right to light and building orientation issues are not protected by legislation).

Support initiatives for PS would include solar access legislation, solar certification and directory, promotion of PS as part of a zero-energy home program, tax credits for advanced windows, and solar procurement by government. More details are provided below.

#### IMPLEMENTING SOLAR INITIATIVES IN ONTARIO

The remainder of this section summarizes 14 initiatives

**TABLE 24**

Summary of policy initiatives to increase solar energy use in Ontario

Initiative	Technology					Program type			
	SHW	SPH	SAV	PV	PS	L	M	S	T
i. Solar access legislation	X	X	X	X	X	X			
ii. AREM marketing				X		X	X	X	
iii. Solar ready	X			X			X		
iv. Solar financing program	X		X	X					X
v. Solar certification & performance directory	X	X					X	X	
vi. PV early adopters program				X				X	
vii. Expanding corporate income tax write-off	X		X						X
viii. Setting a minimum solar fraction in the building code						X	X		
ix. Improve commercial building codes			X			X	X		
x. Expansion of existing tax incentives to solar heat	X		X						X
xi. Removal of RST from high energy efficiency windows						X			X
xii. Solar pool initiative		X	X			X		X	X
xiii. Solar on government buildings	X			X	X		X		
xiv. Net Zero Energy Home Initiative	X			X	X		X	X	X

Note:

Technology

SHW – Solar Hot Water  
 SPH – Solar Pool Heating  
 SAV – Solar Air Ventilation  
 PV – Photovoltaic  
 PS – Passive Solar

Program Type

L – Legislation  
 M – Marketing  
 S – Support  
 T – Tax Changes

recommended for developing Ontario's solar sector, and greatly increasing the province's use of all solar technologies. These initiatives can also complement existing federal programs such as the Renewable Energy Deployment Initiative (REDI) of Natural Resources Canada.<sup>63</sup>

**i. Solar access legislation:** Although the use of PV and solar thermal systems is still rather limited, the time is fast approaching when these technologies will be within the reach of most households in Ontario. To maximize the use of these technologies, provincial and municipal governments should consider how to safeguard solar access for future use and for situations where new building construction obstructs an existing solar system (thereby reducing energy generation). These issues are critical to all solar technologies and can significantly improve the technical potential on new homes.

Currently, existing zoning and various covenants are instead creating barriers to the use of solar energy by putting restrictions on the few systems that can be installed on houses and other buildings. In a number of documented cases homeowners are now not allowed to install SDHW systems on roofs, and many municipalities ban the most basic of solar collectors – i.e. an outdoor clothesline.<sup>64</sup> The area of solar legislation and right to sun-light has lagged far behind the development of solar technologies.

The legal protection of solar access would be a first step in promoting an increased use of solar energy and would demonstrate government support for the technology.

**ii. Advanced Renewable Tariffs (REMs) – legislation and marketing:** A new provincial act or legislation setting up REMs should be introduced as soon as possible, to ensure large-scale renewable energy deployment in Ontario and to support the implementation of solar PV.

Participation in the REMs system will be influenced by a number of issues:

- Consumer awareness of REMs, and of financial and non-financial benefits of renewable energy;
- Technology availability and cost;
- Financing rates and terms;
- Ease of implementation;
- The incentive of REMs payments.

To maximize widespread provincial participation in REMs it will be necessary to have more than just legislation. Many of these issues can be addressed through good program design, education campaigns, and good marketing.

**iii. Solar ready: preparing homes for solar technologies:** Currently new residential housing units are not being built with their potential for solar being considered or designed for upgrading. By preparing a house during the construction phase for later solar energy use, there can be significant cost savings. As well, solar systems will be better incorporated and more aesthetically pleasing.

A “solar-ready” standard needs to be developed and marketed to builders with the intent of integrating it into the building code or high performance housing codes.

**iv. Solar financing: paying from solar savings:** While the Canadian market for solar technologies continues to expand faster than the use of conventional energy sources, having to pay for a solar system in one lump sum puts a damper on most consumers' purchasing enthusiasm, and also restricts the system size that people can afford.

Car dealers would sell few cars if customers were expected to pay the full sticker price in one payment. How can it be expected that a large number of consumers will buy a solar system without favourable financing? If solar is to be marketed effectively it must be financed by an agency, which, for tax and investment reasons, is prepared to take a ten-year investment horizon – thus effecting a lowering of monthly payments below the value of the monthly savings.

There are many international examples of solar financing programs. The German and Japanese solar roof programs provide valuable templates.<sup>65</sup> The aim of such initiatives is to simplify investment by individuals and small and medium companies and to bring the monthly payments of the solar system down below the monthly energy savings. In this case the payback on solar systems is immediate and the consumer payback acceptance curve approaches 100%.

Low interest loans at less than market rates reduce loan payments and generation costs. This incentive, already used in a number of countries, takes the form of an interest rate “buy down”, which allows lenders to offer solar loans at a reduced interest rate and reduces the overall cost.<sup>66</sup>

The incentive applied as an interest rate subsidy is a small share of the total financing, with a lender having to provide most of the capital. Price distortion is minimal as the program subsidizes the financing cost and not the capital cost. The level of total incentive provided through an interest rate subsidy is much less than with other approaches and can overcome the major barrier of payback acceptance.

This financing mechanism can be carried out through a number of different agencies or financing models including solar banks, solar mortgages, solar leasing or solar energy service companies (ESCOs). Appropriate delivery agents would include utilities, conventional banks, and ESCOs.

However, because there is a lack of an existing example of this mechanism in Canada, it is unlikely that a private financing firm would undertake solar financing without an underwriting of the risks. Government could provide a “risk subsidy” in the range of 30–50% above standard interest rates to change this situation.<sup>67</sup>

A solar financing initiative run by a government agency would allow this mechanism to enter the market place and increase confidence in solar technologies. Solar financing would then slowly evolve onto a number of potential private financing agencies including utilities and banks.

**v. Solar certification and performance directory program:** A number of institutional barriers exist to the wider deployment of solar domestic hot water (SDHW) systems in Ontario. Many of these relate to a lack of codes, standards and guidelines, and to a lack of knowledge on the part of decision-makers. As a direct result, there have been recent examples in Canada where building permits have been denied for the installation of SDHW systems<sup>68</sup>, homes in which SDHW systems have been installed are denied insurance coverage and insurance policies threatened to be cancelled, and water heater rental organizations have stated that they will void service contracts if a SDHW system is installed onto the customers’ rented water heater.<sup>69</sup>

Before solar domestic hot water systems begin to be deployed on a large scale in Ontario these barriers must be removed. It is expected that there will be an updated CSA certification available for SDHW systems in place by the fall 2004. However the solar manufacturing firms in Canada are small and with the current low sales volume in Canada, it is not expected that many firms would submit their systems for testing and certification without government financial support.

**vi. PV early adopters program:** PV-generated electricity is not yet an economically viable alternative to conventional electrical generation – the payback for individual customers currently exceeds 25 years. Yet the PV industry in Canada is, each year, increasing its sales into the grid connected markets, and these sales cannot

be explained by using a conventional payback acceptance curve. These sales in fact represent an “early adopter” market. While this market is small, it should be nurtured, as it is essential for public familiarization with the technology, and for industry to prepare for mass deployment in the future.

The program proposed would include:<sup>70</sup>

- PV systems to be installed over a 10-year period (1,000 per year);
- Systems that would average 3kW;
- Favourable REMs that would be guaranteed for 20-year period from date of installation;
- Program would last 20 years.

**vii. Expanding the 100% corporate income tax write-off for electrical generation:** Currently there is a proposed 100% provincial corporate income tax write-off for the cost of assets used to generate electricity from renewable energy sources. Solar heating is currently not eligible for the write-off. This write-off should be expanded to include renewables that generate heating and cooling.

**viii. Setting a minimum solar fraction in the building code:** Currently, while the Ontario Building Code mandates certain minimum levels of energy efficiency in house construction, it does not set standards for solar fraction. With the advent of simple computer simulations on home energy demands it is possible for builders to determine a building’s solar fraction.

It is recommended that a minimum solar fraction for all new homes be set at 25% as a requirement in the Building Code.

**ix. Improve commercial building codes:** Commercial Building Codes should also be improved to include the requirements for on-site energy generation using PV and minimum fractions of solar thermal. There are no commercial building sites in Ontario that could not use active solar technologies if the building is designed and sited for solar use during the building design stage.

**x. Expansion of existing tax incentives to solar heat:** Currently there are a variety of tax incentives available, or being implemented, that are targeted for either residential renewable systems (electricity and heat) or corporations (for electricity produced from renewable energy sources). However, solar air ventilation systems are excluded. By expanding existing tax incentives to

include solar heat, the payback for systems will become more attractive for commercial energy consumers.

Currently there is an RST rebate for the purchase of qualifying building materials incorporated into commercial facilities to generate electricity from renewable energy or energy from deep lake water-cooling facilities. Commercial applications using solar heating are currently not eligible. By amending this limitation to include renewables that generate heat energy, the price difference between a solar air ventilation wall and a metal wall will be reduced to about 15% and would make the installation of solar air ventilation cheaper than a brick wall.

**xi. Removal of RST from high efficiency windows:** The principle of tax shifting has already been partially initiated in Ontario by the removal of retail sales tax (RST) from solar equipment and hybrid cars.

The principle of tax shifting should be expanded to include removal of RST on high efficiency windows (these windows can make a significant effect on lowering the heating needs of a home). Like other solar products the RST should be removed from solar windows to promote their contribution of energy to Ontario's energy mix.

**xii. Solar pool initiative:** Swimming pools are considered by many as a luxury item and the use of conventional energy sources such as electricity and natural gas for their heating entails environmental problems. Today there are more than 100,000 pools in Ontario that are heated using natural gas or electricity. Various jurisdictions in Europe and the U.S. have limited the used of conventional heaters for swimming pools.<sup>71</sup>

A combination of a 20% tax on pool heaters using a non-renewable energy source (natural gas and electricity) and a loan program with an interest rate subsidy for solar pool heaters would reduce the costs of solar systems to under a 2-year payback. Increased taxation on pool heaters using non-renewable energy sources would be in place permanently while the loan program (with five-year terms) could be in place for 10 years starting in 2005. It is estimated that the pool heater tax would raise \$27 million over the 10-year period and these funds could be directed to fund solar programs around Ontario.

A long-term, local, focused marketing program is proposed that would run in conjunction with the proposed tax on pool heaters that use non-renewable sources. NRCan marketing in Vancouver, Niagara Falls, and Montreal illustrated their effectiveness.<sup>72</sup>

**xiii. Solar on government buildings:** This program would target the deployment of PV systems on government buildings and schools with the target of installing 100 kW per year on high profile buildings. The purpose is to expose architects and builders to the potential of using PV as a building material. BIPV can be cost-competitive much faster than rooftop PV as it displaces conventional building materials. If the cladding material it displaces is expensive (i.e. granite or architectural glass curtain walls) then PV can be competitive in a short timeframe.

**xiv. Net Zero Energy Home (NZEH) initiative:** By removing the GST and PST for a limited time from new NZEH homes, the cost of a NZEH would be equal to a conventional home.

The target would be to have all new homes built by 2030 to integrate on-site energy generation using PV, solar hot water, passive, and other technologies. The target by 2025 would be to have 40,000 new homes a year installed with SDHW.

## 4. Conclusions and further research

Ontario has a unique opportunity to take advantage of its solar resources for the generation of clean and reliable electricity and heat. Solar technologies allow the generation of electricity and heat unhindered by volatile fuel costs. They also represent a growing industry able to generate large numbers of good quality jobs.

Ontario could join leading jurisdictions in grid-connected PV by designing and enacting renewable energy mechanisms (REMs) to provide stable prices for electricity generated by PV systems and to ensure the right to interconnection of these systems to the province's grid.

REMs are a key policy strategy that needs to be complemented by a series of strategic solar initiatives (summarized in Table 24), which will enable the province to address effectively existing financial, education, and public awareness barriers currently hampering the deployment of solar technologies in Ontario.

It should be noted that many of the incentives identified for solar systems would not be needed if the environmental and public health costs of conventional energy sources were included in their price or if the current subsidies to the fossil fuel and nuclear sectors were phased out.

Further research is required to quantify and regularly update the environmental, social, and grid infrastructure costs of current forms of electricity generation. This is

an essential step to ensure more accurate price comparisons between distributed generation options, such as PV, and fossil fuel and nuclear-generated electricity. In addition, a detailed analysis of the total available surface

to install solar systems (similar to that currently underway to map wind resources) needs to be commissioned to increase public awareness and to facilitate market participation.

### **SOLAR PLANT A BOOST TO ONTARIO'S ECONOMY**

A major solar cell manufacturing plant in southwestern Ontario is helping put Canada on the map as a leader in renewable energy.

Cambridge, Ontario, is home to Canada's first full-scale solar cell manufacturing plant, which opened in June 2004. Automation Tooling Systems (ATS) expects its 193,000 square foot facility will soon be producing revolutionary new photovoltaic technology in commercial quantities.

Not only will it expand Canada's presence in the global photovoltaic marketplace, the plant will also create 200 jobs and the investment of more than \$100 million in the Canadian economy by the end of 2005.

Currently, the primary markets of this solar manufacturer are international. Changes in the public policy environment could establish significant domestic opportunities for this and other Ontario-based solar industries.

ATS expects its solar technology will accelerate

the adoption of solar energy by consumer and commercial users – and open new mainstream applications because it can be manufactured cost-effectively. The resulting solar cells are pliable, lightweight, durable, and can be produced in a variety of colours that suit seamless integration with traditional building materials.

The solar cells use silicon to convert sunlight into electricity. This new technology incorporates thousands of tiny silicon spheres, bonded between thin flexible aluminum foil substrates to form solar cells. Developed in Canada using Canadian engineering and scientific expertise, the technology is considered to be major breakthrough for the estimated \$3.4 billion global solar photovoltaic industry.

The Cambridge facility will produce 20 megawatts per year, capable of providing electricity for one year for 6,000 homes.

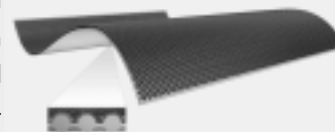

### CHICAGO: A GREEN LEADER

In 2001, the city of Chicago launched an aggressive campaign to make it the most environmentally friendly city in the world. In just three years, the city has become a clean energy leader by bringing renewable and efficient energy to government, homes and businesses.

Chicago set a goal to purchase 20 percent of its municipal power from renewable energy by 2006 – it has already reached 15 percent and expects to hit the 20 percent target two years ahead of schedule. Chicago is now one of the largest non-utility purchasers of renewable energy in the U.S. It expects to cut energy costs by a total of \$260 million by 2010.

The city has also launched a program that provides various incentives to help city residents buy and improve historic bungalows. The program offers loans, energy conservation grants, free architectural assistance, and streamlined permits to anyone who purchases a bungalow for upgrading. In addition, the city supplies vouchers for energy-efficient appliances and matching grants for efficient windows, doors and insulation.

The city is supporting transformations to large manufacturers such as metal casters, chemical producers and sweets manufacturers. Each year, Chicago chooses one industry and helps it to improve energy use, prevent pollution and prosper economically. The goal is to achieve energy savings of 10 to 25 percent for each company.

### GERMAN CITY A SOLAR SUCCESS

Freiburg is considered the solar capital of Germany. Solar panels are commonly found on homes, hotels, sports arenas, schools, businesses and institutes in this city of 200,000 people.

Home to hundreds of environment-related companies, Freiburg is the envy of urban areas attempting to capitalize on the green energy boom.

Freiburg is host to *Solar Fabrik*, Germany's largest manufacturer of installation-ready solar modules. *Solar Fabrik* operates a zero emissions factory, Europe's first CO<sub>2</sub>-neutral production facility for solar modules. The facility uses a combination of solar panels and solar design to achieve zero emissions.

Freiburg, a university city, is also home to Europe's largest solar energy research institute and Germany's first emission-free hotel.





## SOLAR CHAPTER NOTES

- 1 Although there are a few provincial studies that focus on specific solar technologies studies; for example see: Smiley, E. (2002). Green Energy Study for British Columbia Phase 2: Mainland Building Integrated Photovoltaic Solar and Small-Scale Wind. Burnaby: BCIT Technology Centre. Available at [http://www.bchydro.com/rx\\_files/environment/environment\\_3929.pdf](http://www.bchydro.com/rx_files/environment/environment_3929.pdf)
- 2 Chart supplied by Doug McClenahan, NRCan – presentation at CanSIA Forum – 2002.
- 3 Natural Resources Canada. (2000). A Buyer's Guide to Solar Water Heating Systems. Ottawa: NRCan. Available at [www.canren.gc.ca/app/filerepository/AC5201041AFA42A1BFD51EA128F787CF.pdf](http://www.canren.gc.ca/app/filerepository/AC5201041AFA42A1BFD51EA128F787CF.pdf)
- 4 Ciorba, U., Pauli, F., Menna, P. (2004). Technical and economical analysis of an induced demand in the photovoltaic sector. *Energy Policy*, 32 (8), 949–960.
- 5 Maycock, P. (2004). PV market update. *Renewable Energy World*, 7 (4), 86–101.
- 6 Ibid (note that all decimal figures were rounded up).
- 7 Sawin, J.L. (2004). Mainstreaming Renewable Energy in the 21st Century. Washington DC: Worldwatch Institute. Available at [www.worldwatch.org](http://www.worldwatch.org), also see Makower, J., Pernick, R., Friendly, A. (2003). *Solar Opportunity Assessment Report*. Washington, DC: Solar Catalyst Group. Available at [www.solarcatalyst.com](http://www.solarcatalyst.com)
- 8 Ibid. Sawin 2004.
- 9 Maycock (2004) op.cit. Note 5. These two key factors, guaranteed REMs for 20 years and long-term financing programs, have helped Germany to become a world leader in PV.
- 10 International Energy Agency Photovoltaic Power Systems Programme. (2002). *Trends in Photovoltaic Applications: Survey report of selected IEA countries between 1992 and 2002*. Available at [www.iea-pvps.org](http://www.iea-pvps.org)
- 11 Weiss, W., Bergman, I. and Faninger, G. (2004) Solar Heating Worldwide: Markets and Contribution to Energy Supply. Gleisdorf, Austria: IEA Solar Heating & Cooling Programme. Available at [www.iea-shc.org/welcome/welcome\\_page.htm](http://www.iea-shc.org/welcome/welcome_page.htm)
- 12 See Stryi-Hipp, G. Germany's case study in Weiss, W. (2004). Solar heating systems: status and recent developments. *Renewable Energy World*, 7 (4), 214–225.
- 13 Ibid. The act currently under design, known as the Regenerative Heating Act, would operate as Germany's Renewable Energy Act by placing a levy on conventional heating sources (primarily oil and gas), and use the proceeds from the levy to pay a premium for every kWh of heat generated by renewable sources.
- 14 Market demand for solar PV has been growing at a rate of 30–40% per year for the past five years and could approach 50% growth in 2004 through demand in the boom markets of Japan, Germany and since 2000 California for details see Eckhart, M. (2004). Growth Markets for PV: PV market outlook is bullish. *Renewable Energy World*, 7 (4), 191–195.
- 15 For more details about PV technology see [www.iea-pvps.org](http://www.iea-pvps.org)
- 16 Peuser, K., Remmers, H., Schnauss, M. (2002). *Solar Thermal Systems: Successful Planning and Construction*. Berlin: Solarpraxis.
- 17 Natural Resources Canada. (1999). *Potential for Solar Heating of Outdoor Residential Pools to 2020*. Ottawa: NRCan.
- 18 For more details on hybrid systems see CANMET's hybrid info publications at [http://cetc-vareennes.nrcan.gc.ca/en/er\\_re/pva\\_sapv/p\\_p.html](http://cetc-vareennes.nrcan.gc.ca/en/er_re/pva_sapv/p_p.html)
- 19 Natural Resources Canada. (2002). *Renewable Energy in Canada: Status Report*. Ottawa: NRCan. Available at <http://www2.nrcan.gc.ca/es/oerd/english/View.asp?x=700>
- 20 See Islam, M., Fartaj, A. Ting, D. (2004). Current utilization and future prospects of emerging renewable energy applications in Canada. *Renewable and Sustainable Energy Reviews*, 8 (6) 493–519.
- 21 Personal communications with Xantrex, TDL, SSP, and Conserval, 2003–2004.
- 22 For more information on the job skills required for the renewable and details on the job areas directly connected to the solar industry see Peartree Solutions. (2003). *Situation Analysis of the Knowledge, Competencies, and Skill Requirements of Jobs in Renewable Energy Technologies in Canada*. Ottawa: Industry Canada.
- 23 According to Peartree Solutions (2003) employment estimates: PV industry = 1,000 jobs; solar water industry = 120 jobs; and solar air industry = 60 jobs. According to NRCan, the Canadian PV industry generated revenues of \$100 million and employed approximately 615 people in 2003, for more details see Ayoub, J. and Dignard Bailey, L. (2003). *Photovoltaic Technology Status and Prospects: Canadian Annual Report 2003*. Ottawa: Natural Resources Canada. Available at [http://cetc-vareennes.nrcan.gc.ca/en/er\\_re/pva\\_sapv/p\\_p.html](http://cetc-vareennes.nrcan.gc.ca/en/er_re/pva_sapv/p_p.html)
- 24 Discussions with TDL, Enerworks, Solcan, Conserval in February, 2004
- 25 Industry Canada. (2003). *Unleashing the Potential of On-Grid PV in Canada: An Action Plan to make PV an integral Component of Canada's Energy Future*. Ottawa: Industry Canada. Available at [www.cansia.ca/canreports.htm](http://www.cansia.ca/canreports.htm)
- 26 The range of recent estimates of PV employment (per MW of PV) indicate: 82 jobs (from note 50); 35.5 jobs (\*Clean Edge); 30 (\*REEP); 184.6 (\*CAL SEIA); 13–32 (\*Massachusetts Institute of Technology); 36.6 (\*Vermont) for units of measure and information for all aforementioned sources indicated by the sign \* see Weissman, J. (2004). Interstate Renewable Energy Council Working Memo: Workforce Development Labor Forecasts & Job Trends for the Solar and Renewable Energy Industries. Latham, New York: Interstate Renewable Energy Council. Available at <http://www.irecusa.org/> Also see Kammen,

- D. Kapadia, K and Fripp, M. (2004). *Putting Renewables to Work: How Many Jobs Can the Clean Energy Industry Generate?* Berkeley: University of California, Renewable and Appropriate Energy Laboratory. Available at <http://ist-socrates.berkeley.edu/~rael/>
- <sup>27</sup> Ayoub and Dignard Bailey (2003) op.cit note 23.
- <sup>28</sup> See Islam et al. (2004) op. cit. note 20.
- <sup>29</sup> For more details see NRCan's solar radiation atlas available at <http://atlas.gc.ca/site/english/maps/archives/5thedition/environment/climate/mcr4076>
- <sup>30</sup> PV Build Cool, [www.pvcoolbuild.com](http://www.pvcoolbuild.com), European Commission (under the 5<sup>th</sup> Framework, contract No. NNE5/2000/115) provides definitions of appropriate building surfaces which include:
- **Flat Roofs:** The definition of a flat roof used is a roof with an angle of between 0°–15°. These surfaces will require a support rack to maximize yearly energy production and proper liquid flow for active systems, and special measures need to be taken to insure watertight construction.
  - **Pitched Roofs:** These are defined as roofs between 15°–75°. A support rack may be required in some applications to maximize energy production, however, this type of surface is the easiest to install on for small systems. Systems can be surface-mounted, integrated, or rack-mounted.
  - **Façades:** A façade is defined as construction between 75°–115°. System types could include closed façade (curtain walls) that are not part of the main construction of the building but forms a protective skin on the outside (i.e. windows, see-through PV modules), and open façade (rain screens) that is an open system that is mounted to the front of the façade.
- <sup>31</sup> Based on data from: Natural Resources Canada. (2004). Energy Use Data Handbook 1990 to 2002. Available online at <http://oee.nrcan.gc.ca/neud/dpa/home.cfm?PrintView=N&Text=N>
- <sup>32</sup> Ibid.
- <sup>33</sup> See Housing Market Indicators, Ontario, 1990–2002 in Canadian Mortgage and Housing Corporation. (2003). Canadian Housing Observer. Ottawa: CMHC. Available at [www.cmhc-schl.gc.ca/en/cahoob/index.cfm](http://www.cmhc-schl.gc.ca/en/cahoob/index.cfm)
- <sup>34</sup> See Natural Resources Canada (2004) op.cit. note 31.
- <sup>35</sup> EnerCity Guide – Draft; European Commission.
- <sup>36</sup> See Natural Resources Canada (2004) op.cit. note 31.
- <sup>37</sup> Estimate on energy production provided by John Hollick, Conserva Engineering, May 26, 2004.
- <sup>38</sup> The calculations presented here rely on the same methodology as a 1993 NRCan report (the most current on this topic), which estimated that 3.75% of air ventilation heating needs could technically be provided by SAV see NRCan (1993). *Solar Heating in Canada to the Year 2020*. Ottawa: NRCan.
- <sup>39</sup> Ontario, and most of Canada, had a body of common law in place to ensure homeowners' right to the sunlight falling on their property until the early 1900s when these laws were abolished due to pressure exerted by housing developers (see Planning Measures to Safeguard Solar Access for Buildings in Ottawa"; Discussion Paper CD164–6, City of Ottawa Community Development Department, 1981). In the U.S., many state solar access laws were enacted in the late 1970s. These laws usually include both covenant restrictions and solar easement provisions. The states' covenant restrictions prevent planning and zoning authorities from prohibiting or unreasonably restricting the use of solar energy. Solar access laws have been implemented in California, Colorado, Hawaii, Indiana, Massachusetts, Minnesota, Montana, Nebraska, Nevada, New Mexico, New York, Utah, Wisconsin, and Wyoming for more details see New Zealand Energy Efficiency & Conservation Authority & Solar Industries Association of New Zealand. (2002). Review of Overseas Initiatives that have been taken to Increase the Uptake of Solar Water Heating. Available at [www.solarindustries.org.nz/documents/overseas\\_initiatives.pdf](http://www.solarindustries.org.nz/documents/overseas_initiatives.pdf)
- <sup>40</sup> See Natural Resources Canada (2004) op.cit. note 31.
- <sup>41</sup> See Natural Resources Canada (2000) op.cit. note 3.
- <sup>42</sup> Based on Natural Resources Canada (2004) op.cit. note 31.
- <sup>43</sup> See Natural Resources Canada (1999) op.cit note 17 – data prorated to 2001 which is being used here as the base year.
- <sup>44</sup> Natural Resources Canada. (1989). *Passive Solar Potential in Commercial Buildings: Four Case Studies*. Ottawa: NRCan.
- <sup>45</sup> Energy Research Group. (1994). *Daylighting in Buildings*. Dublin: School of Architecture, University College Dublin. Available at [www.cordis.lu/opet/src/thrm029.htm](http://www.cordis.lu/opet/src/thrm029.htm)
- <sup>46</sup> Referenced in Natural Resources Canada. (1993). *Active Solar Heating in Canada to the Year 2010*. Ottawa: NRCan.
- <sup>47</sup> The term 'innovators' is used to note a certain percentage of individuals will purchase a new product or technology regardless of the economics. These innovators currently account for a significant proportion of solar customers. There has not been a study done in Canada to determine the percentage of Canadians that could be considered potential innovators of solar – this is the current market for solar technologies until existing barriers are removed.
- <sup>48</sup> For more details about this innovative educational program see Renewable Energy Program of the Association of Canadian Community Colleges at [www.accc.ca/english/services/renewable\\_energy\\_links.cfm](http://www.accc.ca/english/services/renewable_energy_links.cfm)
- <sup>49</sup> Projections supplied by Spheral Solar Products, May 2004.
- <sup>50</sup> See Winfield, M.S., Horne, M., McClenaghan, T. and Peters, R. (2004). *Power for the Future: Towards a Sustainable Electricity System for Ontario*. Calgary: Pembina Institute for Appropriate Development, and Canadian Environmental Law Association available at [www.pembina.org](http://www.pembina.org)
- <sup>51</sup> Personal communication with Enerworks and Thermo-Dynamics, May 2004.
- <sup>52</sup> See Natural Resources Canada (2004) op.cit. note 31.
- <sup>53</sup> See Maycock (2004) op.cit. note 5.

- <sup>54</sup> For specific country figures see the system prices section of the International Energy Agency's Photovoltaic Power Systems Programme at [www.oja-services.nl/iea-pvps/topics/i\\_costs.htm](http://www.oja-services.nl/iea-pvps/topics/i_costs.htm)
- <sup>55</sup> Eckhart (2004) op.cit note 14.
- <sup>56</sup> See Sawin, J. (2004). *National Policy Instruments: Policy Lessons for the Advancement and Diffusion of Renewable Energy Technologies Around the World*. Bonn: Secretariat of the International Conference for Renewable Energies. Available at [www.renewables2004.de/pdf/tbp/TBP03-policies.pdf](http://www.renewables2004.de/pdf/tbp/TBP03-policies.pdf)
- <sup>57</sup> Weiss and Faninger (2004) op.cit. note 11.
- <sup>58</sup> Ibid.
- <sup>59</sup> See Weiss and Faninger (2004, p.222) op.cit. note 11.
- <sup>60</sup> Some of these issues have been previously analyzed in Pape, A. (1999). *Clean Power at Home*. Vancouver: The David Suzuki Foundation.
- <sup>61</sup> Net Metering is usually understood as measuring the electricity used in a building versus the electricity generated using a renewable energy system. This calculation results in a 'net' energy total from which an electricity bill is calculated. Sawin (2004, p.6) op.cit note 56 observes that California and Texas did not achieve positive results from net metering for wind power or PV, and only achieved positive results until other incentives were added to the mix. Although her research indicates that net metering might have greater impact if private generators were to receive time-of-use rates for the electricity they generate the fact remains that feed-in laws have been successfully used to make countries such as Germany into world leaders in renewable energy technologies such as PV.
- <sup>62</sup> For more information about a national initiative to develop and implement a Canadian guideline for the interconnection of small, distributed power sources see MicroPower Connect's web site at [www.micropower-connect.org](http://www.micropower-connect.org)
- <sup>63</sup> For more details about REDI see <http://www2.nrcan.gc.ca/es/erb/erb/english/view.asp?x=455>
- <sup>64</sup> Discussions with Peter Sajko, Thermodynamics Ltd in May 2004 – situation in NS.
- <sup>65</sup> See Sawin (2004) op. cit. note 56.
- <sup>66</sup> New Zealand's government program provides subsidies for those customers who take out a loan for solar domestic water system and the subsidy is equal to the interest rate for the first year for more details see Solar Industries Association of New Zealand at [www.solarindustries.org.nz](http://www.solarindustries.org.nz). In the US the states of California (SMUD), Idaho, Iowa, Nebraska, Oregon, Virginia, and Texas all have financing programs in place with low interest loans backed by the government or utilities (see NZ Energy Efficiency & Conservation Authority and NZ Solar Industries Association (2002). *Review of Overseas Initiatives that Have Been Taken to Increase the Uptake of Solar Water Heating*. Available at [www.solarindustries.org.nz/info\\_solar.html#pub](http://www.solarindustries.org.nz/info_solar.html#pub)). India has over 100,000 such loans outstanding for solar water heating systems and this mechanism has now been introduced into the PV market and has already funded approximately 18,000 solar electric homes see Painuly, J. Usher, E. (2004). Got finance? A model to develop the PV market in South India. *Renewable Energy World*, 7 (1), 86–93.
- <sup>67</sup> Canadian Solar Industries Association. (1983). *Third Party Financing of Solar Energy Systems – Phase 1 Report*. Ottawa: CanSIA.
- <sup>68</sup> Presentation at the CanSIA 2003 forum, November 2003 – City of Ottawa is currently not allowing the installation of any solar DHW system which is not CSA certified however the testing procedure for the standard is not in place yet.
- <sup>69</sup> Discussions with George Hay, May 2004
- <sup>70</sup> A similar system is suggested by Rowlands, I. (in press). Envisaging feed-in tariffs for solar photovoltaic electricity: European lessons for Canada. Forthcoming in *Energy Policy*.
- <sup>71</sup> Discussions with Joe Thwaites, Taylor Munro Energy, and Dan Takahashi, Enersol.
- <sup>72</sup> NRCan ran small focused marketing programs in the early 2000s in Vancouver, Niagara Falls and Montreal, and there was a significant increase in public awareness in these regions. As the programs were extremely limited (one year long) and no monitoring of sales was done it is impossible to judge the success of the programs. However, industry members in the areas where the programs occurred have stated that it did have a positive impact on their sales over the following year (discussions with Joe Thwaites, Taylor Munro Energy Systems, May 2004).

# 7

## Conclusion

**AFTER YEARS OF NEGLECT**, Ontario is in a unique position to transform its power system in a truly sustainable manner. Renewable energy and conservation will help protect the environment and public health while strengthening the economy, creating a brighter and better future for Ontario. Investing in renewable energy sources will give Ontario the most reliable electricity system, cost-effective power, cleaner air, and new jobs.

For example, in terms of jobs, if the renewable energy options summarized in Table 3 of the introduction are fully implemented by 2010, Ontario could have 25,000 people working in the renewable energy sector. By 2020 this sector could employ 77,000.<sup>1</sup>

The most sustainable path forward for Ontario is investment in energy efficiency, the creation of a conservation culture, and strong support for renewable energy.

Taking advantage of these opportunities will require effective policy decisions that: create stable demand for renewable energy technologies; ensure favourable access to the electricity grid at fair prices; facilitate low-cost financing; provide tax incentives; legislate standards; support education initiatives; and encourage active stakeholder participation.

Effective policies will also help ensure the province's renewable sources are tapped in a sustained and stable manner, positioning Ontario as a North American leader in renewable energy.

All forms of electricity in Ontario have been or are currently subsidized. The playing field, however, is very unequal. If direct and indirect subsidies to conventional sources of electricity were removed, and the immense environmental and public health costs associated with fossil fuel and nuclear energy were included, renewable energy would not require the degree of support

outlined in this report. Even with the modest subsidies recommended, renewable energy is the most cost-effective, reliable, sustainable solution to Ontario's electricity crisis.

Currently, Ontario is relying on polluting coal-fired power plants and aging nuclear plants. It's an unsustainable combination – coal plants contribute to southern Ontario's poor air quality and summer smog, while nuclear plants are plagued with unresolved safety issues, chronic underperformance, and massive cost overruns. The large scale adoption of natural gas electricity plants is plagued with problems: dwindling domestic supply, price volatility and greenhouse gas emissions. Moreover, all of these centralized plants exacerbate the problems of Ontario's expensive and increasingly fragile transmission grid. Getting out of this crisis is not possible with the same type of thinking that led us into it.

Because of their distributed nature, renewable energy technologies offer the most reliable, stable, and cost effective options for new energy. It is time for Ontario's priorities to change.

So far, the province has set a modest goal to have 2,700 megawatts of renewable energy generation by 2010 (about 10 per cent of Ontario's current total installed capacity). *Smart Generation: Powering Ontario with Renewable Energy* shows that the province can achieve a much larger target.

*Smart Generation* urges Ontario's decision makers to develop five sources of renewable energy – wind, hydro-electricity, biomass, geothermal, and solar – while creating a strong focus on conservation and energy efficiency.

In light of the Ontario government's promise to shut down the province's coal-fired power plants by 2007, the need for sustainable alternatives has never been greater.

Confronting the serious public health consequences of coal-fired utilities creates an unparalleled opportunity to dramatically reduce the province's and the country's greenhouse gas emissions, addressing the most urgent crisis confronting humanity in the 21<sup>st</sup> century – climate change. Phasing out coal with conservation, efficiency, and renewable energy would reduce greenhouse gas emissions by about 38.4 megatonnes from 2000 levels.<sup>2</sup> This reduction represents 16 percent of Canada's Kyoto target.<sup>3</sup>

As illustrated throughout this report renewable energy options are already here and they are working with great success in countries as diverse as Germany, Spain, and Japan. Ontario has a lot of catching up to do. But it can be done.

Ontarians can continue to take the province down the unsustainable road of boosting supply by continuing to finance highly centralized, polluting and volatile sources such as natural gas or nuclear power, or can instead take a sharp turn towards investing in a healthier, reliable, and locally based electricity system.



Wind turbines, biomass and several other forms of renewable energy can create new sources of income for farmers and generate good quality jobs throughout Ontario, while providing a reliable local supply of energy.

## CONCLUSION NOTES

- <sup>1</sup> In this report it is estimated that the renewable energy sector could lead to the following employment creation:
- Wind: 100,000 person-years of cumulative employment by 2012
  - Hydro: 240 jobs by 2020
  - Biomass: 1472-6,181 jobs by 2010-2020
  - GHP: 18,750 jobs by 2010 and 51,150 jobs by 2020
  - Solar: 19,442 jobs by 2025

To calculate total employment by 2010 we converted the wind estimate of person-years to total jobs per MW by averaging this type of employment over the life of the wind facilities as described in page 6 of Kammen, D.M., Kapadia, K, and M. Fripp (2004) *Putting Renewables to Work: How Many Jobs Can the Clean Energy Industry Generate?* RAEI Report, University of California, Berkeley. Available at <http://ist-socrates.berkeley.edu/~rael/renewables.jobs.pdf> Following this approach, the person-years estimate is then divided by the average life of the wind facilities (i.e. 20 years) resulting in 5,000 jobs for 8,000 MW of wind turbines. For these calculations we are assuming that the estimated solar jobs will increase linearly from 2005 to 2025, i.e.  $19,442/20=972$  jobs per year; however, we do not include any solar jobs in the 2010 calculation to provide a more conservative estimate.

- <sup>2</sup> Stewart, K. (2003). Ontario and Kyoto. Ottawa: Climate Action Network. Available at [www.climateactionnetwork.ca/resources.html](http://www.climateactionnetwork.ca/resources.html)
- <sup>3</sup> Canada's Kyoto commitment entails reducing annual greenhouse gas (GHG) emissions by 240 megatonnes (MT) see Government of Canada. (2003). *Climate Change Plan for Canada*. Available at [www.climatechange.gc.ca/plan\\_for\\_canada/](http://www.climatechange.gc.ca/plan_for_canada/)

# Appendix: Ontario Energy Profile

## Summary

Renewable energy can be used for the production of electricity, and for residential, commercial, and industrial building space conditioning (heating, cooling, and hot water). This appendix presents a brief overview of the demand for power and space conditioning in Ontario.

## 1. Present structure of Ontario's electricity sector

The past five years have been a period of extraordinary change and upheaval in Ontario's institutions and policies related to electricity. Competitive retail and wholesale electricity markets were introduced in May 2002. In response to public concerns over the sudden increases in electricity prices, the government terminated the competitive retail electricity market in November 2002, and introduced a fixed electricity *production* price of 4.3 cents/kWh. This fixed price was abandoned as of April 1, 2004 going to 4.7 cents/kWh for the first 750 kWh and 5.5 ¢/kWh for use above that level, a positive step to encourage conservation.

Ontario's total installed generation capacity is close to 30,000 megawatts (MW). The bulk of Ontario's installed power capacity is owned by Ontario Power generation (OPG). As of September 2003, OPG had a total in-service installed capacity of 22,733 MW (nuclear facilities = 6,103 MW; coal and oil powered stations = 9,700 MW; hydroelectric stations = 6,796 MW; low-impact hydroelectric facilities = 134 MW).<sup>1</sup> In addition, Bruce Power controls nuclear reactors with a total installed capacity of 6,660 MW.<sup>2</sup>

In 2003 Ontario's electricity demand totaled 152 terawatt-hours (TWh).<sup>3</sup>

The present fuel supply mix for electricity production is shown in Figure 1.

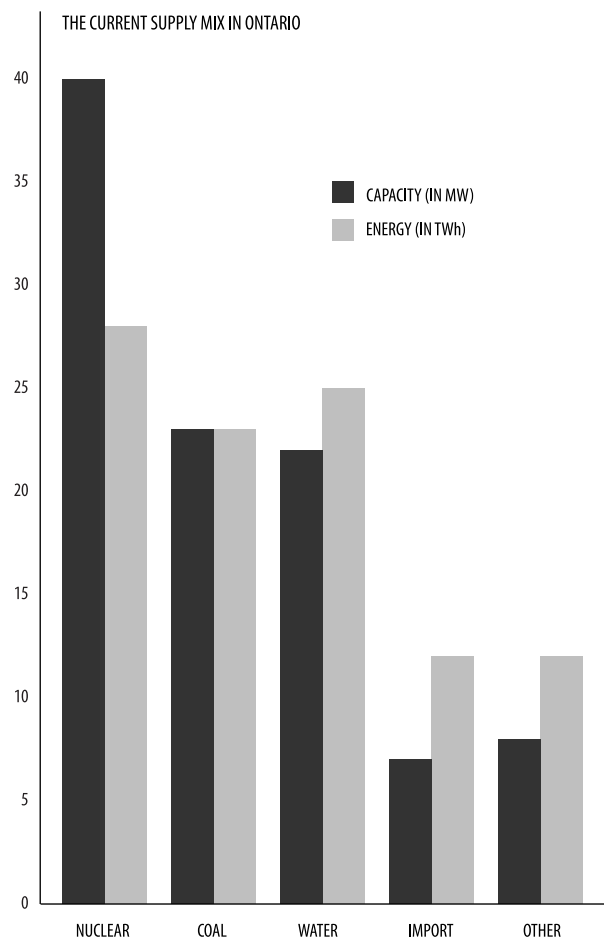

FIGURE 1 The current supply mix in Ontario<sup>4</sup>

## EXPECTED ELECTRICITY PRICE

The report *Power for the Future* shows an Ontario Electricity sales price forecast prepared by Natural Resources Canada.<sup>5</sup> The report authors consider these expectations reasonable for Ontario.

**TABLE 1**

Ontario's electricity sales price forecast (cents/kWh), 2000–2020<sup>6</sup>

	2000	2005	2010	2015	2020
Commercial	8.30	8.50	9.22	9.98	10.79
Industrial	6.30	5.38	5.83	6.31	6.82
Residential	10.00	10.24	11.11	12.03	13.00

While until April 1, 2004, the residential price for production was 4.3 cents per kWh, once other fixed and variable charges were added; the effective consumer price in Ontario is about 10 cents per kWh.<sup>7</sup> This price excludes the immense environmental and public health costs of the current energy mix, and it also does not include subsidies to nuclear and fossil power.

## 2. Heat demand

Contrary to electricity, heat cannot be transported at a long distance. The end-use and the location of the end user are important factors estimating the possibilities for renewable energy. In this section, the heat demand of relevant sectors is analysed with help of statistic information available from the Historical Database of Natural Resources Canada, Office of Energy Efficiency (available at [http://oee1.nrcan.gc.ca/Neud/dpa/comprehensive\\_tables/](http://oee1.nrcan.gc.ca/Neud/dpa/comprehensive_tables/))

### RESIDENTIAL SECTOR

Table 2 shows the secondary energy use of the 4.4 million households in Ontario. It is interesting to observe that space heating and water heating account for 58% and 21% of the domestic energy demand, respectively. The energy share of cooling is only 2.5% of the total energy demand, but will be an important factor during summer peaks of electricity use.

**TABLE 2**

Total secondary energy use in the residential sector in 2001 in Ontario, by energy source (PJ)<sup>8</sup>

	Total Share	(%)	Space heating	Water heating	Space cooling	Other
Electricity	159.9	31%	34.7	22.5	13	89.7
Natural gas	302.3	59%	216.1	83.8	–	2.4
Heating oil	29.1	6%	26.8	2.3	–	0.0
Propane	4.1	1%	3.4	0.6	–	0.1
Other <sup>a)</sup>	0.0	0%	0.0	0.0	–	0.0
Wood	16.7	3%	16.7	0.0	–	0.0
<b>Total</b>	<b>512.1</b>	<b>100%</b>	<b>297.7</b>	<b>109.2</b>	<b>13</b>	<b>92.2</b>

<sup>a)</sup> "Other" includes coal and steam

The possibility of using renewable energy systems depends on the type of building. Table 3 shows that most heat demand for space heating arises from single detached houses.

**TABLE 3**

Secondary energy use of space & water heating in the residential sector, by type of building (PJ)<sup>9</sup>

	Space heating	Water heating
Single detached	222.0	61.7
Single attached	36.0	16.5
Apartments	37.8	30.3
Mobile homes	2.0	0.8
<b>Total</b>	<b>297.8</b>	<b>109.3</b>

### COMMERCIAL AND INSTITUTIONAL SECTOR

The commercial and institutional sector consists of diverse types. Figure 2 shows that offices use 47% of the energy used in this sector. Public institutions, such as schools, are often suitable for renewable energy demonstration programs.

In Table 4 the division of energy demand into energy sources is shown. Natural gas is a major energy carrier, providing about 53% of the commercial and institutional energy demand.

As in the domestic sector, space heating is the dominant energy application with respect to final energy use (see Table 3).

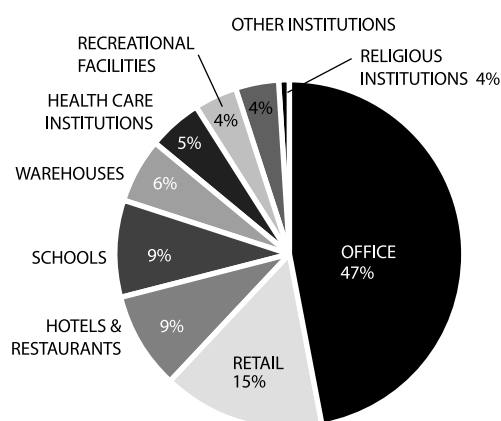

**FIGURE 2** Total secondary energy use in the commercial and institutional sector by type of building (PJ) in Ontario (2001)<sup>10</sup>

**TABLE 4**

Secondary energy use in the commercial and institutional sector by energy source in Ontario in 2001 (PJ)<sup>11</sup>

	Total	Offices	Schools
Electricity	164.9	74.1	7.4
Natural gas	226.6	104.7	26.2
Light fuel oil and kerosene	17.2	8.0	2.0
Heavy fuel oil	7.5	3.7	0.6
Propane	7.5	3.7	0.9
Other <sup>a)</sup>	0.3	0.2	0.0
<b>Total</b>	<b>424.0</b>	<b>194.4</b>	<b>37.1</b>

<sup>a)</sup> "Other" includes coal and steam.

### 3. Price of heat

Natural gas is the dominant conventional energy source for heat applications. About 59% of the household energy demand is supplied by natural gas. Heating oil and propane provide 6% and 1% of the secondary energy demand in the residential sector, respectively, presumably at locations with no connection to the natural gas network, which creates an opportunity for renewable energy heating.

If pollution and health costs are totally ignored, natural gas is currently the cheapest option for heating but these prices are expected to rise in the future (see below). Heating oil (15.2 \$/GJ) and propane (21.7 \$/GJ) are more expensive. Heating with electricity is the most expensive. The costs of heating equipment should also be taken into account.

At the wholesale level, natural gas supply prices throughout North America are determined by the dynamics of supply and demand. These prices fluctuate constantly. Short-term prices are particularly volatile

**TABLE 6**

Secondary energy use in Ontario's industry by energy source in 2001 (PJ)<sup>14</sup>

	Total	Paper and pulp industry	Cement industry	Iron and steel industry
Electricity	161.9	33.1	3.3	22.7
Natural gas	289.9	34.0	1.3	48.1
Light fuel oil, diesel fuel oil and kerosene	27.0	0.7	0.0	0.4
Heavy fuel oil	33.8	6.7	1.4	7.2
Still gas and petroleum coke	85.5	0.0	5.7	0.0
LPG and gas plant NGL	3.1	0.0	0.0	0.0
Coal, coke and coke oven gas	139.9	0.6	16.7	119.8
Wood waste and pulping liquor	83.0	83.0	0.0	0.0
Other <sup>a)</sup>	15.7	2.5	4.0	0.0
<b>Total</b>	<b>839.8</b>	<b>160.6</b>	<b>32.4</b>	<b>198.2</b>

<sup>a)</sup> "Other" includes steam and waste fuels.

**TABLE 5**

Secondary energy use in the commercial and institutional sector by end use in Ontario in 2001 (PJ)<sup>12</sup>

	Total	Offices	Schools
Space heating	224.5	111.0	27.3
Water heating	24.8	5.1	2.5
Auxiliary equipment	34.4	17.8	0.6
Auxiliary motors	43.1	15.2	2.3
Lighting	61.7	32.0	3.2
Space cooling	33.0	13.4	1.2
Street lighting	2.6	-	-
<b>Total</b>	<b>424.1</b>	<b>194.5</b>	<b>37.1</b>

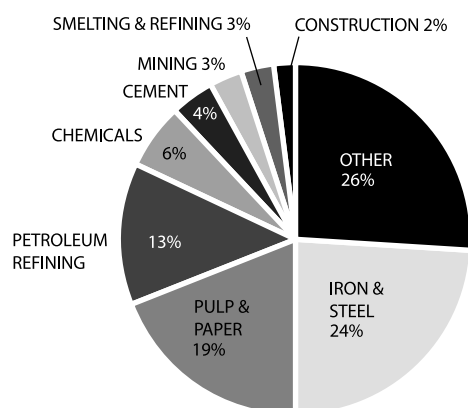

FIGURE 3 Secondary energy use in Ontario's industry by sub sector in 2001 (PJ)<sup>13</sup>

owing to factors such as the weather, which can affect not only demand but also supply. It is observed that in 2003 prices of 7 \$/GJ were paid for natural gas. In the longer-term, gas prices are affected by population and economic growth, the prices of substitutes such as fuel oil, and by environmental policies. For example, greater



demand for gas as a preferred fuel for electricity generation has resulted in higher gas prices.

The price that utilities have to pay for gas supply is determined in a competitive wholesale market. As long as the OEB is satisfied that the utility's purchasing strategy is appropriate, it is allowed to recover its gas costs by means of the supply charge billed to users who buy their gas supply from the utility.<sup>15</sup>

**TABLE 7**

Ontario's natural gas price forecast (\$/GJ), 2000–2020<sup>16</sup>

	2000	2005	2010	2015	2020
Commercial	5.25	5.79	6.41	6.97	7.61
Industrial	3.61	3.97	4.40	4.76	5.18
Residential	6.37	7.01	7.76	8.46	9.25

The natural gas price forecast summarized in Table 7 shows steadily growing natural gas prices for all sectors.

## APPENDIX NOTES

- <sup>1</sup> See OPG “systems at a glance” at [www.opg.com/ops/systems.asp](http://www.opg.com/ops/systems.asp) OPG also owns wind-powered facilities totaling 2.4 MW see Canadian Wind Energy Association “Canada’s installed capacity” at [www.canwea.ca/en/CanadianWindFarms.html](http://www.canwea.ca/en/CanadianWindFarms.html)
- <sup>2</sup> For more details see Bruce A and Bruce B at [www.candu.org/brucepower.html](http://www.candu.org/brucepower.html)
- <sup>3</sup> See “demand overview” at [www.theimo.com/imoweb/media/md\\_demand.asp](http://www.theimo.com/imoweb/media/md_demand.asp)
- <sup>4</sup> Source: Electricity Conservation & Supply Task Force. (2004). *Tough Choices, Addressing Ontario’s Power Needs: Final Report to the Minister*. The report is available at [www.energy.gov.on.ca/english/pdf/electricity/TaskForceReport.pdf](http://www.energy.gov.on.ca/english/pdf/electricity/TaskForceReport.pdf)
- <sup>5</sup> Analysis and Modelling Group. (2000). *Canada’s Emissions Outlook: An Update*. Ottawa: National Climate Change Process.
- <sup>6</sup> Source: p.14 of Winfield, M.S., Horne, M., McClenaghan, T. and Peters, R. (2004). *Power for the Future: Towards a Sustainable Electricity System for Ontario*. Calgary: Pembina Institute for Appropriate Development and Canadian Environmental Law Association, available at [www.pembina.org](http://www.pembina.org).
- <sup>7</sup> For more details see [www.theimo.com/imoweb/siteShared/other\\_charges.asp?sid=ic](http://www.theimo.com/imoweb/siteShared/other_charges.asp?sid=ic).
- <sup>8</sup> Source: Natural Resources Canada, Office of Energy Efficiency available online at: [http://oee1.nrcan.gc.ca/Neud/dpa/comprehensive\\_tables/](http://oee1.nrcan.gc.ca/Neud/dpa/comprehensive_tables/)
- <sup>9</sup> Ibid.
- <sup>10</sup> op.cit. note 8.
- <sup>11</sup> op.cit. note 8.
- <sup>12</sup> op.cit. note 8.
- <sup>13</sup> op.cit. note 8.
- <sup>14</sup> op.cit. note 8.
- <sup>15</sup> The Ontario Energy Board (OEB) sets the rates that Enbridge Consumers Gas, Union Gas and Natural Resource Gas can charge for selling, distributing, transporting and storing gas.
- <sup>16</sup> Source: p.14 of Winfield et al. (2004), op.cit. note 6.

## Glossary of Key Terms

- BASE LOAD** The minimum continuous load over a period time.
- CAPACITY** The maximum continuous power output of a given generating facility. Individual generator or station capacity is commonly rated in kilowatts (kW) or megawatts (MW).
- CAPACITY CREDIT** The capacity rating multiplied by an “availability factor” which reflects the availability of the generating source to be on-line when required. The capacity credit is a measure of the amount of dependable, dispatchable capacity that a system operator can rely on from an individual generating station.
- CAPACITY FACTOR** The ratio of actual expected energy production to total potential energy production, given the nameplate rating of a power plant.
- CAPACITY RATING** The nameplate (maximum) capacity of a generating source multiplied by the average time the generating source is available to generate power. For renewable energy generators such as wind turbines, the capacity rating is primarily determined by the wind resource available in a given area.
- CONSERVATION (OF ENERGY)** Any activity, program or technology that reduces the amount of energy consumed. Turning off lights when leaving a room or installing a high-efficiency appliance which consumes less energy than the unit it replaces are examples of conservation.
- DEMAND SIDE MANAGEMENT** Any action or program that reduces current uses of energy.
- DISPATCHABLE GENERATION** An electrical generation source that is capable of automatically, or through remote control, adjusting its output in response to real-time load conditions of the grid.
- ENERGY EFFICIENCY** The amount of energy used by an apparatus or process to complete a given task.
- GIGAWATT-HOUR (GWH)** Power unit equal to one million kilowatt-hours. In 2003 Ontario’s electricity demand was approximately 416 GWh per day.
- GRID (DISTRIBUTION)** A network of medium and low-voltage power lines interconnecting the grid transmission system with industrial, commercial and residential load customers.
- GRID (TRANSMISSION)** A network of high-voltage, long-distance power lines interconnecting generating facilities with distant electrical distribution systems.
- HEADPOND** The upstream catchment area or run-of-river water feed supplying the hydropower station. Head refers to the vertical drop through which water must fall before expending its energy on the turbine blades. A comparison of similar sites, with one having higher head will produce more energy. A hydropower site with water storage in the catchment area can produce peak energy at a rate higher than can be supplied by water inflows. A run-of-river site can generate peak energy equal to the maximum instantaneous inflow of water.
- HERITAGE GENERATING ASSETS** Government-owned power generating assets which are sufficiently old as to have their capital costs depreciated to zero. Heritage generating assets produce electrical power at the lowest rates, which skews public perception when comparing energy costs of new, capital intensive facilities.
- I.M.O.** The (Ontario) Independent Electricity Market Operator is a non-profit, regulated corporation established by the electricity act that sets forth terms and operating conditions of the wholesale

electricity market and management of the high-voltage transmission grid. The IMO is expected to be replaced through new legislation.

- INTERMITTENT POWER SOURCE** An electrical generation unit whose output changes due to variability of the input energy source.
- KILOWATT (KW)** 1,000 watts of power. The capacity of a small kettle, iron or hairdryer.
- KILOWATT-HOUR (KWH)** The amount of electrical energy produced or consumed when one kilowatt of power is used for one hour. For example, ten 100-watt light bulbs burning for one hour would consume one KWh of energy.
- LOSSES (TRANSMISSION SYSTEM)** The energy that is lost as heat due to electrical resistance in a given length of transmission system. In Ontario approximately 8% of all electricity generated is lost due to transmission system resistance.
- LOAD** The amount of electrical power that is instantaneously required at any given part of the electrical system.
- MEGAWATT (MW)** Power unit equal to one million watts. Current wind turbines range in size from ~1–5 MW each.

- MEGAWATT-HOUR** The amount of energy produced or used when one megawatt of power is consumed for one hour. As energy is the product of power and time, one megawatt-hour of energy would also be produced if a generating station were to deliver 500 kWh for two hours.
- OFF-PEAK PERIOD** The period of time (whether considered daily, seasonally or yearly) when energy use is below its maximum level.
- PEAK-USE PERIOD** The opposite of off-peak period.
- PEAKING CAPACITY** An electrical generator that is typically used only to meet the energy requirements of peak or high-demand periods. Peak generation is normally provided by hydroelectric or gas turbine generators.
- PETAJoule** A petajoule (PJ) is equivalent to  $10^{15}$  joules. The joule is the official standard unit of energy. 1 million tonnes of coal equivalent = approximately 28 PJ (assuming 100% conversion efficiency), and 7.3 million barrels of oil = approximately 42 PJ (assuming 100% conversion efficiency).
- WHEELING** The act of transmitting blocks of energy on the high-voltage transmission system between a generation source and load.



Ontario is at a critical energy crossroads. The province's decision makers are about to choose how Ontario will produce and use electricity in the coming decades.

The choices they make will profoundly affect all Ontarians. They can either take the province down the same road of boosting supply to meet increasing demand or forge a new path towards a more sustainable electricity system with renewable energy and conservation.

*Smart Generation: Powering Ontario With Renewable Energy*, urges Ontario's decision makers to develop the province's abundant renewable sources of energy while creating a new focus on conservation. In return, Ontario will get a more reliable, cost-effective electricity system, cleaner air, more jobs, and the development of a new and vibrant economic engine.

*Smart Generation* summarizes the potential of five sources of renewable energy for Ontario: wind, hydropower, biomass, geothermal and solar. It also makes key policy recommendations on how to rebuild the province's power system with these sources of energy.



David  
Suzuki  
Foundation

SOLUTIONS ARE IN OUR NATURE

The David Suzuki Foundation works through science and education to protect the diversity of nature and our quality of life, now and for future generations. We seek the best research to provide innovative solutions that will help build a clean, competitive economy that does not threaten the natural services that support all life.

2211 West 4th Avenue, Suite 219  
Vancouver, BC, Canada V6K 4S2  
[www.davidsuzuki.org](http://www.davidsuzuki.org)  
Tel (604) 732-4228  
Fax (604) 732-0752

OCTOBER 2004